

SITRAM



French Durable Professional



Saint-Benoît-du-Sault

In the heart of France



A cookware manufacturer since more 50 years.

SITRAM is the French pioneer of stainless steel cookware. The Sitram factory was established in 1963 in Saint-Benoît-du-Sault, France. For over 50 years, Sitram has been the premiere manufacturer of premium stainless steel kitchen equipment. A central geographic location, a skilled workforce and a focus on innovation have been paramount to the distinguished heritage of Sitram.

DURING the 80's, Sitram became a prominent player in French kitchenware. Sitram's famous TV slogan left a lasting impression on several generations: « si vous ne prenez pas une SITRAM, vous risquez de prendre une gamelle ! » (if you don't cook with a Sitram pan, you will take a « gamelle ». Play on words: « gamelle » means a slip or a pan in a real poor condition).

SITRAM is a leader in manufacturing technology. Sitram invented modern fabrication for enameled cooking utensils. Rather than using outdated methods of soaking utensils to create an enameled finish, Sitram developed new manufacturing technologies to create higher quality products with greater durability. While competitors were using the stirrup principle as the closure system for the pressure cooker, Sitram developed a safer and improved pressure cooker. By introducing the bayonet closure system, Sitram added safety features and improved performance by retaining pressure inside the cooking vessel.

SITRAM products are ideal for discriminating home gourmets, and professional chefs. Sitram commercial equipment is used in top restaurants and hotels in global markets. Collaboration with leading chefs, experts in technology and specialists in manufacturing are central to Sitram's product development. The brand remains one of the last manufacturers of commercial equipment in France.



A beautiful story



1963

SITRAM factory is established and begins operations in Saint Benoît-du-Sault; France.



1960

SITRAM is created by F. COMBE to produce premium stainless steel cooking equipment for global markets.



1982

SITRAM introduces the first range of non-stick cooking products.



1963

First SITRAM pressure cookers with stainless steel construction are sold in France.



1998

Launch of the « Cybernox » range: a premium non-stick coating with metallic alloy.



1990

SITRAM launches the tv spot campaign with the famous slogan « si vous ne prenez pas une SITRAM, vous risquez de prendre une gamelle ». « If you don't cook with a Sitram pan, you will take a « gamelle ». Play on words: « gamelle » means a slip or a pan in real poor condition ».



2015

New ranges, new TV advertising campaign.



2013

SITRAM is purchased by Gers Equipement, a French company based in the Gers area, South of France, specializing in Art of the Table and cooking products for mass markets.

Entre nous, c'est du solide

SITRAM

A know how
French quality

DEDICATED to discriminating home gourmets and global commercial businesses, Sitram cookware and utensils are created for style, **durability** and **comfort**.

SINCE 1963, the Sitram brand has been known as a **leader in stainless steel equipment for commercial kitchens throughout Europe**. Sitram supplies prestigious international hotels groups and has an excellent global reputation in the hospitality business.

SITRAM **performance** and **durability** can be found in all premium cookware ranges. Sitram cookware is ideal for professional kitchens as all products perform at high temperatures and stand up to frequent use.

SITRAM is the leader in the pressure cookers market. The Sitram brand is synonymous with product innovation, quality and safety for all kitchens.



LES AUTOCUISEURS / PRESSURE COOKER

- SITRAPRO (Made in France)
- SITRAMASTER (Made in France)
- SITRAPRIMO (Made in France)
- SQUADRA (Made in France)
- SITRASPEEDO (Made in France)
- SITRASPEEDO Couleur (Made in France)
- SITRAMONDO (Made in France)
- SITRAFORZA (Made in France)
- SITRAMAX (Made in France)
- VERSION ORIGINALE (Made in France)
- EASTAR

L'INOX / STAINLESS STEEL

- COLLECTIVITÉ - Casseroles, poêles, sauteuses / Saucepan-frypan-deep frypan (Made in France)
- COLLECTIVITÉ - Rondeaux, braisières, traiteurs, couvercles / Stewpan-deep stewpan-stockpot-lid (Made in France)
- COLLECTIVITE PRO - Casseroles, poêles, sauteuses, faitouts / Saucepan-frypan-deep frypan-deep stewpot (Made in France)
- COLLECTIVITE PRO - Rondeaux, traiteurs, couvercles / Stewpan-stockpot-lid (Made in France)
- PRO1 - Casseroles, poêles, faitout / Saucepan-frypan-deep stewpot (Made in France)
- PRO1 - Sauteuses, rondeaux, couscoussier / Deep frypan-stewpan (Made in France)
- PRO1 - Braisières, traiteurs, couvercles / Deep stewpan-stockpot-lid (Made in France)
- BACCHUS PRO (Made in France)
- NICE (Made in France)
- SOFT (Made in France)
- EXPERT
- SITRAPRESTIGE
- RAPSODY
- ATHENA
- HARMONY
- CHARLESTON Black
- CHARLESTON White
- SYMPHONY Color
- SYMPHONY Céram
- LES SPÉCIFIQUES et LES LOTS

L'ALUMINIUM / ALUMINIUM

FORGE D'ALUMINIUM / DIE CAST ALUMINIUM

- VIP PEPPER
- VIP MINERA
- VIP BLACK
- CASTRO
- CASUAL
- DUO
- PAPRIKA
- NUANCE COLOR
- COLORAMA
- COLORAMA FULL

ALUMINIUM FORGÉ / ALUMINIUM

- ÉBÈNE
- BRÉVA
- HÉGOA Black
- HÉGOA White
- HÉGOA Taupe

ALUMINIUM PRESSÉ / ALUMINIUM

- SITRAMULTI
- SITRASEASON
- TITANIUM
- ZÉPHYR
- ALIZÉ

L'ACIER / IRON

FORGE D'ACIER / CAST IRON

- SITRABELLA
- SITRASLOW
- FINESSE

ACIER EMAILLÉ / ENAMELED CAST IRON

- VERMILLON
- CHICKEN COOK

ACIER REVÊTU / IRON

- ZEN

DIVERS / DIVERSE

- PIÈCES DÉTACHÉES / SPARE PARTS
- LES ACCESSOIRES / ACCESSOIRES

Conditionnement Product packaging	
	Boîte quadri Color Box
	Fourreau Color Sleeve
	Boîte Box
	Boîte PET Box PET
	Affichette quadri Color label
	Hang Tag
	Carte Blistercard
	Cavalier Header
	Fardelage Skin wrapped
	Fardelage +Affichette quadri Skin wrapped +Color label
	Vrac Bulk

PRESSURE COOKER



French Durable Professional



Pressure-Cooker SITRAPRO

EASY SINGLE-HANDED
OPENING

STAINLESS
STEEL
18-10

**GLIDE
OPENING
SYSTEM**

**DEPRESSURISATION
SYSTEM
ANTI-SCALD**

**PRESSURE
REGULATOR : 70 kPa**

**LONG-LIFE
SITRAFLEX
SILICONE GASKET**

**ALL HEAT
SOURCES**
INCLUDING INDUCTION



**6 - 8 - 10
LITRES**



Black-taupe



	Reference	Bar code	Colour		Reference	Bar code	Colour
6L	711156	3 108837 111566	Black-Taupe	6L	711159	3 108837 111597	Black-Green
8L	711157	3 108837 111573	Black-Taupe	8L	711160	3 108837 111603	Black-Green
10L	711158	3 108837 111580	Black-Taupe	10L	711161	3 108837 111610	Black-Green

SIMPLICITY

Single-handed
opening/closing
Closing glide system



REGULATOR

2 POSITIONS
anti-scald de-pressurization
system

- Depressurisation
- Cooking



HANDY ACCESSORIES WITH THEIR UNIQUE DESIGN



Steam basket

+



2-in-1 Spoon

+



Option : Measure



▶ SILICONE STEAM BASKET

The 2 handles on this perforated Stainless steel basket make it easy to pull out and stop it tipping over. Entirely developed by Sitram. Easy to clean. Dishwasher-safe.

▶ 2-IN-1 SPOON

The hooked handle end makes it easy to grasp the steam basket.

THE + POINT: it has been specially designed to **keep your worktop clean:** its curved handle prevents the spoon from coming into contact with the surface.

▶ MEASURE (Option)

The **smart accessory :** To **dose out** a liquid quantity thanks to its internal graduations and **to indicate the minimum level** for a good use of the pressure-cooker.

▶ RECIPE BOOKLET WITH 40 SUGGESTIONS



Black-Green



Black-Red



Black-Raspberry

OTHER COLOUR COMBINATIONS

	Reference	Bar code	Colour		Reference	Bar code	Colour
6L	711162	3 108837 111627	Black-Red	6L	711165	3 108837 111658	Black-Raspberry
8L	711163	3 108837 111634	Black-Red	8L	711166	3 108837 111665	Black-Raspberry
10L	711164	3 108837 111641	Black-Red	10L	711167	3 108837 111672	Black-Raspberry

HARD-WEARING

▶ Thick non-warp base, laboratory-tested for optimum even heat diffusion.

SAFETY

4 safety points :

- ▶ 1 opening safety
- ▶ 1 closing safety
- ▶ 2 surpressure safeties
- ▶ Security valve
- ▶ Gasket extrusion



15-year warranty*

* See conditions on the user's manual.

Spare parts available 5 years following the purchasing date.



Pressure-Cooker SITRAMMASTER

ORIGINE
FRANCE®
GARANTIE

BV/Cert - 6192741

SIMPLE, RELIABLE AND FUN

STAINLESS
STEEL
18-10

**BAYONET
OPENING
SYSTEM**

**DEPRESSURISATION
SYSTEM
ANTI-SCALD**

**PRESSURE
REGULATOR : 70 kPa**

**LONG-LIFE
SITRAFLEX
SILICONE GASKET**

**ALL HEAT
SOURCES**
INCLUDING INDUCTION



**6 - 8 - 10
LITRES**



Black-taupe



	Reference	Bar code	Colour		Reference	Bar code	Colour
6L	711168	3 108837 111689	Black-Taupe	6L	711171	3 108837 111719	Black-Green
8L	711169	3 108837 111696	Black-Taupe	8L	711172	3 108837 111726	Black-Green
10L	711170	3 108837 111702	Black-Taupe	10L	711173	3 108837 111733	Black-Green



SIMPLICITY

Bayonet **opening** system.
Arrows guide you when
you position the lid for
closing.

REGULATOR

2 POSITIONS

anti-scald de-pressurization
system



Depressurisation



Cooking



ACCESSORIES DESIGNED TO MAKE YOUR LIFE EASY



- ▶ **PROTECTION REMOVABLE STRIP** with cooking instructions. Will protect pressure-cooker from scratches and shock. Available only for 8L/10L/13L. DO NOT USE ON GAS COOKER.



- ▶ **Now for the PLUS :** the handle shape has been specially designed to protect your hands from the hot lid.

- ▶ **STEAM BASKET**
The 2 handles on this perforated **STAINLESS STEEL** basket make it easy to pull out and stop it tipping over.

- ▶ **RECIPE BOOKLET WITH 40 SUGGESTIONS**



Black-Green



Black-Red



Black-Raspberry

OTHER COLOUR COMBINATIONS

	Reference	Bar code	Colour		Reference	Bar code	Colour
6L	711174	3 108837 111740	Black-Red	6L	711177	3 108837 111771	Black-Raspberry
8L	711175	3 108837 111757	Black-Red	8L	711178	3 108837 111788	Black-Raspberry
10L	711176	3 108837 111764	Black-Red	10L	711179	3 108837 111795	Black-Raspberry

HARD-WEARING

- ▶ Thick non-warp base, laboratory-tested for optimum even heat diffusion.

SAFETY

4 safety points :

- 2 surpressure safeties
- ▶ Security valve
- ▶ Gasket extrusion

▶ 1 opening safety

▶ 1 closing safety



15-year warranty*

* See conditions on the user's manual.
Spare parts available 5 years following the purchasing date.



Pressure-Cooker

SITRAPRIMO

ORIGINE
FRANCE®
GARANTIE

BV/CCH-6192741

SIMPLE AND LIGHT

SATIN
STAINLESS
STEEL

BAYONET
OPENING
SYSTEM

PRESSURE
REGULATOR:
65 kPa

NITRILE GASKET

ALL HEAT
SOURCES
INCLUDING INDUCTION



4-6-8-10
LITRES



Black-taupe



SIMPLICITY

- ▶ **Safe locking :**
The notches engage to ensure it closes.
Arrows guide you when you position the lid for closing.

HARD-WEARING

- ▶ **Thick non-warp base,**
laboratory-tested for
optimum even heat
diffusion.

15-year warranty*

* See conditions on the user's manual.
Spare parts available 5 years following the purchasing date.

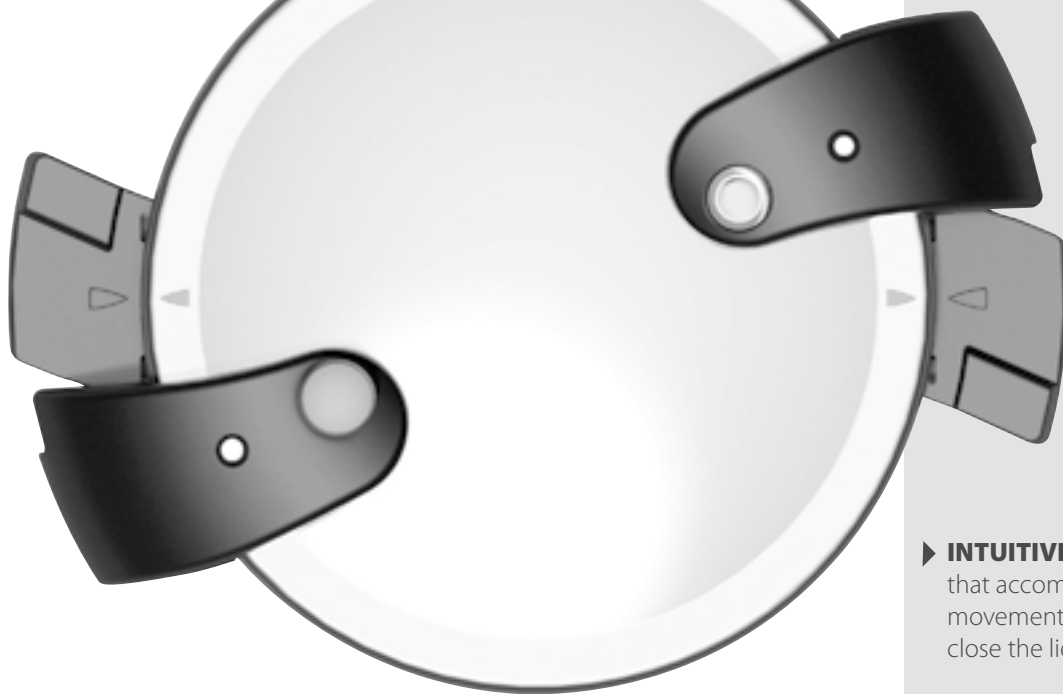

► **INTUITIVE HANDLES**
that accompany your hand movement as you open and close the lid.



► **STEAM BASKET**
in **STAINLESS STEEL** wire with 2 handles that make it easy to pull out and stop it tipping over. Easy to clean. Dishwasher-safe.

	4 L	6 L	8 L	10 L
Reference	711151	711152	711153	711154
Bar code	 3 108837 111511	 3 108837 111528	 3 108837 111535	 3 108837 111542

SAFETY
4 safety points :

- 1 opening safety
- 1 closing safety



2 surpressure safeties

► **Security valve**
► **Gasket extrusion**

MADE IN FRANCE

Made in France, equipped with ergonomic handles on both sides, Squadra offers safe use. Protection cover against heat and burn risks.

SAFE USE

- 2 speed valve
- Speed 1 : 50 kpa slow cooking
- Speed 2 : 100 kpa fast cooking
- Simple opening and closing system: turn the lid and activate the closure knob
- 4 safety devices
- Bayonet closure system
- Ergonomic handle

FINISH

Inside matt and outside shiny polishing

FITMENTS

- Steam basket
- Thermoresistant handle
- Stainless steel 1.5mm lid
- Triple layered sandwich bottom for optimal heat diffusion



PRESSURE COOKER

	REF.	ø cm	ø in	L	qt	Person	Box
	711148	24 / 9,46		6 / 6,34		3-6	1
	711149	24 / 9,46		8 / 8,45		5-8	1
	711150	24 / 9,46		10 / 10,56		7-10	1

QUALITÉ PROFESSIONNELLE
PROFESSIONAL QUALITY



FOND ÉPAIS
diffusion rapide
THICK BASE
fast heat diffusion



GAZ
GAS



ELECTRICITÉ
ELECTRICITY



INDUCTION
INDUCTION



RÉSISTANCE Spirale
ELECTRIC COIL



VITROCERAM
Halogène
CERAMIC
Halogen



MADE IN FRANCE

The elegant French-manufactured Sitraspeedo pressure cooker has become a best-seller.

EFFICIENT, HARD-WEARING AND SIMPLE TO USE

- Pressure: 70kPa
- Single-handed opening and closing
- Secure locking with 4 safety devices
 - Clamp closing

FINISH

Matt inside and mirror-finish outside

ACCESSORIES

- Timer
- Steaming basket
- Screw-fastened heat-resistant handle
- Stainless steel lid
- 3-layer sandwich base for a perfect heat diffusion

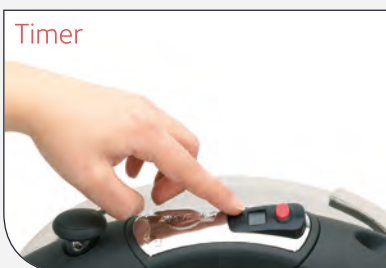
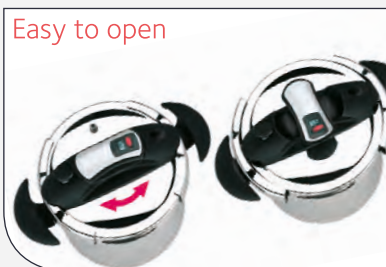

2 colourways: black or red/black

QUALITÉ PROFESSIONNELLE
PROFESSIONAL QUALITY



FOND ÉPAIS diffusion rapide
THICK BASE fast heat diffusion



GAZ
GAS



ELECTRICITÉ
ELECTRICITY



INDUCTION
INDUCTION



RÉSISTANCE Spirale
ELECTRIC COIL



VITROCERAM Halogène
CERAMIC Halogen



PRESSURE COOKER

REF.



• with steaming basket



710131

24 / 9,46

4 / 4,23

2-3

1



710339

• 24 / 9,46

4 / 4,23

2-3

1



• with steaming basket



710132

24 / 9,46

6 / 6,34

4-6

1



710292

• 24 / 9,46

6 / 6,34

4-6

1



710504

24 / 9,46

6 / 6,34

4-6

1



• with steaming basket



710104

24 / 9,46

8 / 8,45

6-9

1



710109

• 24 / 9,46

8 / 8,45

6-9

1



710505

24 / 9,46

8 / 8,45

6-9

1



• with steaming basket



710133

24 / 9,46

10 / 10,56

7-10

1



710149

• 24 / 9,46

10 / 10,56

7-10

1



710503

24 / 9,46

10 / 10,56

7-10

1



• without steaming basket



710481

24 / 9,46

13 / 13,73

8-13

1



• Triple layered sandwich base
• Matt inside and mirror-finish outside



QUALITÉ PROFESSIONNELLE
PROFESSIONAL QUALITY



FOND ÉPAIS diffusion rapide
THICK BASE fast heat diffusion



GAZ
GAS



ELECTRICITÉ
ELECTRICITY



INDUCTION
INDUCTION



RÉSISTANCE Spirale
ELECTRIC COIL



VITROCERAM Halogène
CERAMIC Halogen



MADE IN FRANCE

The elegant French-manufactured Sitraspeedo pressure cooker has become a best-seller.

EFFICIENT, HARD-WEARING AND SIMPLE TO USE

- Pressure: 70kPa
- Single-handed opening and closing
- Secure locking with 4 safety devices
 - Clamp closing

FINISH

Matt inside and mirror-finish outside

ACCESSORIES

- Timer
- Steaming basket
- Screw-fastened heat-resistant handle
- Stainless steel lid
- 3-layer sandwich base for a perfect heat diffusion

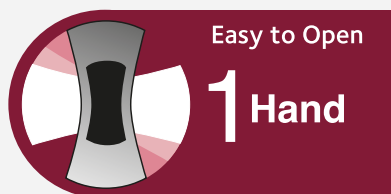

4 colourways: beige – blue – red - plum

QUALITÉ PROFESSIONNELLE PROFESSIONAL QUALITY 	FOND ÉPAIS diffusion rapide THICK BASE fast heat diffusion 	GAZ GAS 	ÉLECTRICITÉ ELECTRICITY 	INDUCTION INDUCTION 	RÉSTANCE Spirale ELECTRIC COIL 	VITROCERAM Halogène CERAMIC Halogen
---	---	----------------	--------------------------------	----------------------------	---------------------------------------	--

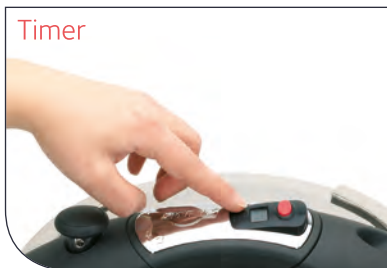

PRESSURE COOKER

REF.



• with steaming basket

	3 108830 524820	710328	•	24 / 9,46	6 / 6,34	4-6	1	
	3 108830 524417	710324	•	24 / 9,46	6 / 6,34	4-6	1	
	3 108830 521317	710294	•	24 / 9,46	6 / 6,34	4-6	1	
	3 108830 522420	710322	•	24 / 9,46	6 / 6,34	4-6	1	



• with steaming basket

	3 108830 524837	710329	•	24 / 9,46	8 / 8,45	6-9	1	
	3 108830 511073	710151	•	24 / 9,46	8 / 8,45	6-9	1	
	3 108830 509094	710148	•	24 / 9,46	8 / 8,45	6-9	1	
	3 108830 522437	710323	•	24 / 9,46	8 / 8,45	6-9	1	



• with steaming basket

	3 108830 524844	710330	•	24 / 9,46	10 / 10,56	7-10	1	
	3 108830 513800	710163	•	24 / 9,46	10 / 10,56	7-10	1	
	3 108830 513077	710150	•	24 / 9,46	10 / 10,56	7-10	1	

• Triple layered sandwich base
• Matt inside and mirror-finish outside



MADE IN FRANCE

Made in France, equipped with ergonomic handles on both sides, Sitramondo offers safe use.

SAFE OPERATION

- Pressure: 65kPa
- Simple opening and closing system: turn the lid when pressing it
 - 4 safety devices
 - Bayonet locking
- Ergonomic bar handle

FINISH

- Matt inside and mirror-finish outside

ACCESSORIES

- Timer
- Steaming basket
- Heat-resistant handle
- 1.5mm thick stainless steel lid
- Triple layered sandwich bottom for optimal heat diffusion



2 colourways: plum or black

QUALITÉ
PROFESSIONNELLE
PROFESSIONAL
QUALITY



FOND ÉPAIS
diffusion rapide
THICK BASE
fast heat diffusion



GAZ
GAS



ELECTRICITÉ
ELECTRICITY



INDUCTION
INDUCTION



RÉSISTANCE
Spirale
ELECTRIC
COIL



VITROCERAM
Halogène
CERAMIC
Halogen



- Triple layered sandwich base
- Matt inside and mirror-finish outside

PRESSURE COOKER

REF.



- with steaming basket



711224

24 / 9,46

6 / 6,34

3-6

1



710394

• 24 / 9,46

6 / 6,34

3-6

1



PRESSURE COOKER



- with steaming basket



710162

24 / 9,46

8 / 8,45

5-8

1



710395

• 24 / 9,46

8 / 8,45

5-8

1



PRESSURE COOKER



- with steaming basket



710215

24 / 9,46

10 / 10,56

7-10

1



710396

• 24 / 9,46

10 / 10,56

7-10

1



Easy to open



Timer



QUALITÉ PROFESSIONNELLE
PROFESSIONAL QUALITY



FOND ÉPAIS diffusion rapide
THICK BASE fast heat diffusion



GAZ
GAS



ELECTRICITÉ
ELECTRICITY



INDUCTION
INDUCTION



RÉSISTANCE Spirale
ELECTRIC COIL



VITROCERAM Halogène
CERAMIC Halogen



MADE IN FRANCE

Made in France, the pressure cooker Sitraforza is ideal for your everyday cooking.

COMPACT AND EFFICIENT

- Pressure : 65 kPa
- Opening and closing by a slight rotation of the lid
 - Secure lock system : 4 safety devices
 - Bayonet closure system

FINISH

Inside matt and outside mirror

ACCESSORIES

- Steam Basket
- Reinforced fitments
- Clipped interchangeable handle
 - Stainless steel lid
- Triple layered sandwich bottom for optimal heat diffusion



QUALITÉ
PROFESSIONNELLE
PROFESSIONAL
QUALITY



FOND ÉPAIS
diffusion rapide
THICK BASE
fast heat diffusion



GAZ
GAS



ELECTRICITÉ
ELECTRICITY



INDUCTION
INDUCTION



RÉSISTANCE
Spirale
ELECTRIC
COIL



VITROCERAM
Halogène
CERAMIC
Halogen





PRESSURE COOKER

REF.

WITHOUT STEAM BASKET



710084

24 / 9,5

4 / 4,2

2-3

1

WITH STEAM BASKET

710085

24 / 9,5

6 / 6,3

3-6

1



WITH STEAM BASKET

710086

24 / 9,5

8 / 8,4

5-8

1

710087

24 / 9,5

10 / 10,5

7-10

1



MADE IN FRANCE

Made in France, the pressure cooker Sitraforza is ideal for your everyday cooking.

COMPACT AND EFFICIENT

- Pressure : 65 kPa
- Opening and closing by a slight rotation of the lid
 - Secure lock system : 4 safety devices
 - Bayonet closure system

FINISH

Inside matt and outside mirror

ACCESSORIES

- Reinforced fitments
- Clipped interchangeable handle
- Stainless steel lid
- Triple layered sandwich bottom for optimal heat diffusion



PRESSURE COOKER

REF.

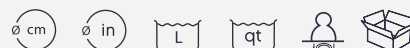

WITHOUT STEAM BASKET



710091

24 / 9,5

13 / 13,7

8-13

1



QUALITÉ PROFESSIONNELLE
PROFESSIONAL QUALITY



FOND ÉPAIS
diffusion rapide
THICK BASE
fast heat diffusion



GAZ
GAS



ELECTRICITÉ
ELECTRICITY



INDUCTION
INDUCTION



RÉSISTANCE Spirale
ELECTRIC COIL



VITROCERAM
Halogène
CERAMIC
Halogen



MADE IN FRANCE

The French-manufactured Version Originale, is the traditionally shaped pressure cooker for preparing your daily meals

EFFICIENT AND EASY

- Pressure: 65kPa
- Opening and closing by a slight rotation of the lid
 - Secure lock system: 4 safety devices
 - Bayonet closure system

FINISH

- Matt Inside and outside

ACCESSORIES

- Steam basket
- Clipped interchangeable black handle
- Stainless steel lid
- Triple layered sandwich bottom for optimal heat diffusion



Opening



Closing



- Triple layered sandwich base
- Matt inside and outside

PRESSURE COOKER

REF.



WITH STEAMER BASKET



710340

24 / 9,46

6 / 6,34

3-6

1



WITHOUT STEAMER BASKET



710888

24 / 9,46

6 / 6,34

3-6

1



WITH STEAMER BASKET



710483

24 / 9,46

8 / 8,45

5-8

1



WITHOUT STEAMER BASKET



710480

24 / 9,46

8 / 8,45

5-8

1



WITH STEAMER BASKET



710554

24 / 9,46

10 / 10,56

7-8

1



WITHOUT STEAMER BASKET



710889

24 / 9,46

10 / 10,56

7-8

1



WITHOUT STEAMER BASKET



710890

10 / 9,46

13 / 13,73

8-13

1



FOND ÉPAIS
diffusion rapide
THICK BASE
fast heat diffusion



GAZ
GAS



ELECTRICITÉ
ELECTRICITY



INDUCTION
INDUCTION



RÉSISTANCE
Spirale
ELECTRIC
COIL



VITROCERAM
Halogène
CERAMIC
Halogen



**Un autocuiseur idéal
pour votre cuisine au quotidien.**
The ideal pressure cooker for everyday use.

FONCTIONNEMENT SÉCURISÉ / SAFE OPERATION

- Pression : 65kPa / *Pressure: 65kPa*
- Fermeture à baïonnette et bouton de déverrouillage
Bayonet closure and release button
- Ouverture et fermeture simple / *Simple opening and closing system*
- Régulateur 2 vitesses / *2-speed regulator*

FINITION/FINISH

- Inox finition intérieure satinée / *Stainless steel satin interior finish*
- Epaisseur corps 1,2 mm / *Body 1.2mm thick*

ACCESSOIRES/ACCESSORIES

- Panier vapeur / *Steam basket*
- Poignée thermorésistante / *Heat-resistant handle*



GAZ



GAZ

ELECTRICITÉ



ELECTRICITY

INDUCTION



INDUCTION

RÉSISTANCE

Spirale

COIL

ELEMENT



VITROCERAM

Halogène

HALOGEN



LAVE

VAISSELLE

DISHWASHER

Safe



NETTOYAGE

FACILE

EASY

TO CLEAN



AUTOCUISEUR / PRESSURE COOKER

REF.

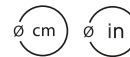

710612

22 / 8,67

7,5 / 7,92

/ 2



- Avec indicateur de pression / with pressure indicator
- Régulateur 2 vitesses / 2-speed regulator



- avec panier vapeur
- with steam basket



710613

22 / 8,67

7,5 / 7,92

/ 2



- Avec indicateur de pression / with pressure indicator
- Régulateur 2 vitesses / 2-speed regulator



- avec panier vapeur
- with steam basket

GAZ



ELECTRICITÉ



INDUCTION



RÉSISTANCE

Spirale
COIL
ELEMENT



VITROCERAM

Halogène
HALOGEN



LAVE

VAISSSELLE
DISHWASHER
Safe



NETTOYAGE

FACILE
EASY
TO CLEAN



STAINLESS STEEL



French Durable Professional

MADE IN FRANCE

Chefs appreciate Collectivité as the as the very best range around. It sports a copper-bottomed base and hard-wearing welded handle designed by Sitram for efficiency that's second to none.

FINISH

- High quality 18/10 stainless steel - Inside and outside matt

ACCESSORIES

- Spot-welded stainless steel parts
 - Stainless steel lid
- Thick copper-bottomed sandwich base for perfect heat distribution
 - Straight lines and collar rim

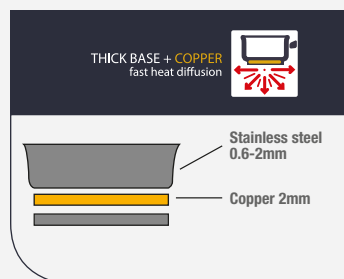

QUALITÉ PROFESSIONNELLE
PROFESSIONAL QUALITY



GAZ



GAS

ELECTRICITÉ



ELECTRICITY

RÉSISTANCE

Spirale

ELECTRIC COIL



VITROCERAM

Halogène

CERAMIC Halogen



LAVE

VAISSELLE

DISHWASHER Safe



NETTOYAGE FACILE

EASY TO CLEAN

EASY TO CLEAN



- Flat incurved anti-roll stick handle

- Straight & collar edge
- Inside and outside matt

SAUCEPAN

REF.



REF.	Ø cm	Ø in	L	qt	Person	Box	Flag
710011	14 / 5,52		0,9 / 0,95		1	5	
710012	16 / 6,30		1,4 / 1,48		1-2	5	
710013	18 / 7,09		2 / 2,11		2-3	5	
710014	20 / 7,88		2,8 / 2,96		3-4	5	
710015	24 / 9,46		5,1 / 5,39		4-5	4	
710016	28 / 11,03		8,3 / 8,77		6-7	3	
710017	30 / 11,82		10,4 / 10,99		7-8	2	

FRYING PAN



REF.	Ø cm	Ø in	L	qt	Person	Box	Flag
710027	20 / 7,88		1,2 / 1,27		1-2	3	
710028	24 / 9,46		1,7 / 1,80		2-3	3	
710029	26 / 10,24		2,1 / 2,22		2-3	3	
710030	28 / 11,03		2,5 / 2,64		3-4	3	
710031	30 / 11,82		3,4 / 3,59		4-5	1	
710032	34 / 13,40		4,3 / 4,54		5-6	1	

SAUTE PAN



710036	24 / 9,46		3 / 3,17		2-4	4	
710037	28 / 11,03		4,6 / 4,86		4-6	4	

FLARED SAUTE PAN



710038	20 / 7,88		1,9 / 2,01		1-2	4	
710039	24 / 9,46		3,1 / 3,28		2-4	2	

FOND ÉPAIS + CUIVRE
diffusion rapide



QUALITÉ PROFESSIONNELLE
PROFESSIONAL QUALITY



GAZ
GAS



ELECTRICITÉ
ELECTRICITY



RÉSISTANCE Spirale
ELECTRIC COIL



VITROCERAM Halogène
CERAMIC Halogen



LAVE VAISSELLE
DISHWASHER Safe



NETTOYAGE FACILE
EASY TO CLEAN



STAINLESS STEEL / LID - STEWPAN - DEEP STEWPAN - STOCKPOT

MADE IN FRANCE

Chefs appreciate Collectivité as the as the very best range around. It sports a copper-bottomed base and hard-wearing welded handle designed by Sitram for efficiency that's second to none.

FINISH

- High quality 18/10 stainless steel - Inside and outside matt

ACCESSORIES

- Spot-welded stainless steel parts
 - Stainless steel lid
- Thick copper-bottomed sandwich base for perfect heat distribution
 - Straight lines and collar rim

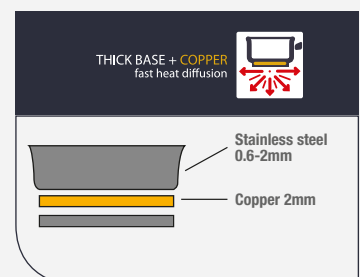

- Straight & collar edge
- Inside and outside matt

LID

REF.



0 052097 018208	710018	16 / 6,30	/	/	1	
0 052097 018215	710019	18 / 7,09	/	/	1	
0 052097 018222	710020	20 / 7,88	/	/	1	
0 052097 018246	710021	24 / 9,46	/	/	1	
0 052097 018253	710022	26 / 10,24	/	/	1	
0 052097 018260	710023	28 / 11,03	/	/	1	
0 052097 018277	710024	30 / 11,82	/	/	1	
0 052097 018284	710025	34 / 13,40	/	/	1	
0 052097 018291	710026	40 / 15,76	/	/	1	

STEWPAN



• with pouring rim

0 052097 018376	710033	30 / 11,82	6,8 / 7,18	4-7	2	
0 052097 018383	710034	34 / 13,40	9,8 / 10,35	6-9	1	
0 052097 018390	710035	40 / 15,76	16,8 / 17,75	10-17	1	

DEEP STEWPAN



• with pouring rim

0 052097 018017	710003	16 / 6,30	1,4 / 1,48	1-2	4	
0 052097 018024	710004	18 / 7,09	2 / 2,11	1-3	6	
0 052097 018031	710005	20 / 7,88	2,8 / 2,96	2-3	6	
0 052097 018055	710006	24 / 9,46	5,1 / 5,39	4-5	1	
0 052097 018079	710007	28 / 11,03	8,3 / 8,77	6-8	2	
0 052097 018086	710008	30 / 11,82	10,4 / 10,99	9-11	2	
0 052097 018093	710009	34 / 13,40	18,7 / 19,76	12-19	1	
0 052097 018109	710010	40 / 15,76	23,5 / 24,83	20-30	1	

DEEP STOCKPOT



0 052097 018444	710040	24 / 9,46	10,5 / 11,09	7-11	1	
0 052097 018468	710041	28 / 11,03	16,5 / 17,43	12-17	1	
0 052097 018475	710042	30 / 11,82	21 / 22,19	18-21	1	
0 052097 018482	710043	34 / 13,40	30 / 31,70	22-30	1	
0 052097 018499	710044	40 / 15,76	50 / 52,83	31-50	1	

THICK BASE + COPPER
fast heat diffusion

<p>QUALITÉ PROFESSIONNELLE PROFESSIONAL QUALITY</p>	<p>GAZ GAS</p>	<p>ELECTRICITÉ ELECTRICITY</p>	<p>RÉSISTANCE Spirale ELECTRIC COIL</p>	<p>VITROCERAM Halogène CERAMIC Halogen</p>	<p>LAVE VAISSELLE DISHWASHER Safe</p>	<p>NETTOYAGE FACILE EASY TO CLEAN</p>
---	--------------------	------------------------------------	---	--	---	---

MADE IN FRANCE

Made in France, high-end range of Sitram professional collections, this serie combines outstanding durability and efficiency. Its solid welded handle meets all the demanding requirements of the most well-known chefs.

FINISH

- High quality 18/10 stainless steel - Matt inside and outside

ACCESSORIES

- Spot-welded stainless steel parts
- Stainless steel lid
- Thick sandwich base for perfect heat distribution

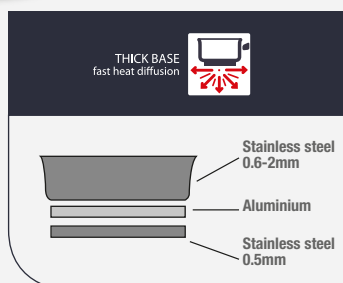

- Flat incurved anti-roll stick handle

- Straight lines
- Collar rim
- Matt inside and outside

SAUCEPAN

REF.

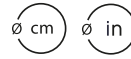

- With pouring rim



710452

14 / 5,52

0,9 / 0,95

1

4



710453

18 / 7,09

2 / 2,11

2-3

4



710454

20 / 7,88

2,8 / 2,96

3-4

4



710295

24 / 9,46

5,1 / 5,39

4-5

4



SAUCEPAN X3



710472

16-18-20 / 6,30-7,09-7,88

1,4-3,3 / 1,48-3,49

1-4

1



FRYING PAN



- With pouring rim



710455

20 / 7,88

1,2 / 1,27

1-2

6



710456

24 / 9,46

1,7 / 1,80

2-3

6



710457

28 / 11,03

2,5 / 2,64

3-4

6



710458

34 / 13,40

4,3 / 4,54

5-6

4



SAUTE PAN



- With stainless steel lid



710459

28 / 11,03

4,6 / 4,86

4-6

4



DEEP STEWPOT



- With stainless steel lid



710460

24 / 9,46

5,1 / 5,39

4-6

2



FOND ÉPAIS
diffusion rapide



QUALITÉ
PROFESSIONNELLE
PROFESSIONAL
QUALITY



GAZ



ELECTRICITÉ
ELECTRICITY



INDUCTION



RÉSISTANCE
Spirale
COIL ELEMENT



VITROCERAM
Halogène
HALOGEN



LAVE
VAISSELLE
DISHWASHER
Safe



NETTOYAGE
FACILE
EASY
TO CLEAN



MADE IN FRANCE

Made in France, high-end range of Sitram professional collections, this serie combines outstanding durability and efficiency. Its solid welded handle meets all the demanding requirements of the most well-known chefs.

FINISH

- High quality 18/10 stainless steel - Matt inside and outside

ACCESSORIES

- Spot-welded stainless steel parts
- Stainless steel lid
- Thick sandwich base for perfect heat distribution



THICK BASE
fast heat diffusion

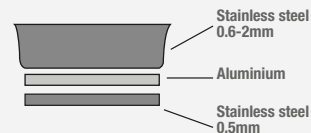

QUALITÉ
PROFESSIONNELLE
PROFESSIONAL
QUALITY



GAZ



ELECTRICITÉ
ELECTRICITY



INDUCTION



RÉSISTANCE
Spirale
COIL ELEMENT



VITROCERAM
Halogène
HALOGEN



LAVE
VAISSELLE
DISHWASHER
Safe



NETTOYAGE
FACILE
EASY
TO CLEAN



- Straight lines
- Collar rim
- Matt inside and outside

STEW PAN

REF.



- With pouring rim

710045 34 / 13,40 9,8 / 10,35 8-12 1

STOCKPOT



- With stainless steel lid

WITH LID
 710449 24 / 9,46 6,4 / 6,76 5-7 2

WITHOUT LID
 710047 24 / 9,46 6,4 / 6,76 5-7 4
 710048 28 / 11,03 10,6 / 11,20 8-10 2
 710050 30 / 11,82 13 / 13,73 11-14 1
 710052 36 / 14,18 18,7 / 19,76 15-20 1
 710054 40 / 15,76 30 / 31,70 15-23 1

DEEP STOCKPOT



WITH LID
 710450 28 / 11,03 16,5 / 17,43 12-17 1

WITHOUT LID
 710046 24 / 9,46 10,5 / 11,09 7-11 2
 710250 26 / 10,24 13,4 / 14,16 7-11 2
 710049 28 / 11,03 16,5 / 17,43 12-17 1
 710051 30 / 11,82 21 / 22,19 18-21 1
 710053 34 / 13,40 30 / 31,70 22-30 1
 710092 40 / 15,76 50 / 52,83 31-50 1

FOND ÉPAIS
diffusion rapide



QUALITÉ
PROFESSIONNELLE
PROFESSIONAL
QUALITY



GAZ



ELECTRICITÉ
ELECTRICITY



INDUCTION



RÉSISTANCE
Spirale
COIL ELEMENT



VITROCERAM
Halogène
HALOGEN



LAVE
VAISSELLE
DISHWASHER
Safe



NETTOYAGE
FACILE
EASY
TO CLEAN



MADE IN FRANCE

Made in France and Sitram professional ranges' best seller, Pro1 is appreciated for its durability and performances.

FINISH

- High quality 18/10 stainless steel - Matt inside and outside

ACCESSORIES

- Fitments made of insulated stainless steel and professional handle
 - Ergonomic
 - Pouring rim
- Stainless steel F17 lid
- Triple layered sandwich base for optimal heat diffusion



THICK BASE
fast heat diffusion

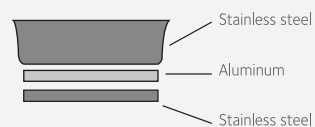

QUALITÉ
PROFESSIONNELLE
PROFESSIONAL
QUALITY



GAZ



GAZ

ELECTRICITÉ
ELECTRICITY



INDUCTION
INDUCTION



RÉSISTANCE
Spirale
COIL ELEMENT



VITROCERAM
Halogène
HALOGEN



LAVE
VAISSELLE
DISHWASHER
Safe



NETTOYAGE
FACILE
EASY
TO CLEAN



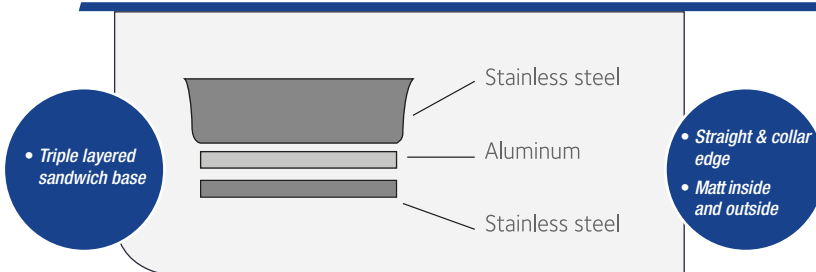

SAUCEPAN WITH POURING LIPS

REF.



REF.	Ø cm	Ø in	L	qt	Person	Box	Flag
710170	12 / 4,73		0,6 / 0,63		1	5	
710171	14 / 5,52		0,9 / 0,95		1	5	
710173	16 / 6,30		1,4 / 1,48		1-2	5	

SAUCEPAN



REF.	Ø cm	Ø in	L	qt	Person	Box	Flag
710169	12 / 4,73		0,6 / 0,63		1	5	
710172	14 / 5,52		0,9 / 0,95		1	5	
710174	16 / 6,30		1,4 / 1,48		1-2	5	
710175	18 / 7,09		2 / 2,11		2-3	5	
710176	20 / 7,88		2,8 / 2,96		3-4	5	
710177	24 / 9,46		5,1 / 5,39		4-5	4	
710178	26 / 10,24		6,7 / 7,08		5-6	3	
710179	28 / 11,03		8,3 / 8,77		6-7	3	
710258	30 / 11,82		10,4 / 10,99		7-8	2	

FRYING PAN



REF.	Ø cm	Ø in	L	qt	Person	Box	Flag
710188	20 / 7,88		1,2 / 1,27		1-2	3	
710189	24 / 9,46		1,7 / 1,80		2-3	3	
710190	28 / 11,03		2,5 / 2,64		3-4	3	
710191	34 / 13,40		4,3 / 4,54		5-6	1	

DEEP STEWPOT



REF.	Ø cm	Ø in	L	qt	Person	Box	Flag
710501	24 / 9,46		5,1 / 5,39		4-6	4	

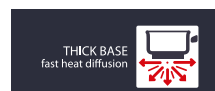

<p>QUALITÉ PROFESSIONNELLE</p> <p>PROFESSIONAL QUALITY</p>	<p>GAZ</p> <p>GAS</p>	<p>ELECTRICITÉ</p> <p>ELECTRICITY</p>	<p>INDUCTION</p> <p>INDUCTION</p>	<p>RÉSISTANCE Spirale</p> <p>COIL ELEMENT</p>	<p>VITROCERAM Halogène</p> <p>HALOGEN</p>	<p>LAVE VAISSELLE</p> <p>DISHWASHER Safe</p>	<p>NETTOYAGE FACILE</p> <p>EASY TO CLEAN</p>
--	-----------------------	---------------------------------------	-----------------------------------	---	---	--	--

MADE IN FRANCE

Made in France and Sitram professional ranges' best seller, Pro1 is appreciated for its durability and performances.

FINISH

- High quality 18/10 stainless steel - Matt inside and outside

ACCESSORIES

- Fitments made of insulated stainless steel and professional handle
 - Ergonomic
 - Pouring rim
- Stainless steel F17 lid
- Triple layered sandwich base for optimal heat diffusion

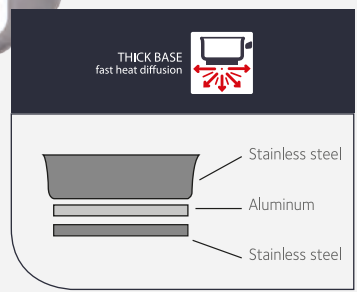

QUALITÉ PROFESSIONNELLE PROFESSIONAL QUALITY 	GAZ GAS 	ELECTRICITÉ ELECTRICITY 	INDUCTION INDUCTION 	RÉISTANCE Spirale COIL ELEMENT 	VITROCERAM Halogène HALOGEN 	LAVE VAISSELLE Safe DISHWASHER 	NETTOYAGE FACILE EASY TO CLEAN
---	----------------	--------------------------------	----------------------------	---------------------------------------	---------------------------------------	--	---------------------------------------

SAUTE PAN

REF.



WITH LID

3 108830 523601	710321	24 / 9,46	3 / 3,17	2-4	4	
3 108830 534010	710502	28 / 11,03	4,6 / 4,86	4-6	3	



WITHOUT LID

0 052097 020232	710195	24 / 9,46	3 / 3,17	2-4	4	
0 052097 020249	710261	28 / 11,03	40,6 / 4,86	4-6	4	

CONICAL SKILLET



WITH LID

3 108830 524486	710325	24 / 9,46	3,1 / 3,28	2-4	4	
-----------------	---------------	-----------	------------	-----	---	--



WITHOUT LID

3 108831 027665	710196	18 / 7,09	1,4 / 1,48	1	4	
0 052097 033522	710197	20 / 7,88	1,9 / 2,01	1-2	4	
0 052097 020256	710187	24 / 9,46	3,1 / 3,28	2-4	4	

STEW PAN



0 052097 032464	710192	30 / 11,82	6,8 / 7,18	4-7	1	
0 052097 032471	710193	34 / 13,40	10 / 10,56	8-12	1	
0 052097 032488	710194	40 / 15,76	16,8 / 17,75	13-17	1	

COUSCOUSSIER



0 052097 034178	710080	24 / 9,46	10,5 / 11,09	/	2	
-----------------	---------------	-----------	--------------	---	---	--

THICK BASE
fast heat diffusion



<p>QUALITÉ PROFESSIONNELLE PROFESSIONAL QUALITY</p>	<p>GAZ GAS</p>	<p>ELECTRICITÉ ELECTRICITY</p>	<p>INDUCTION INDUCTION</p>	<p>RÉSISTANCE Spirale COIL ELEMENT</p>	<p>VITROCERAM Halogène HALOGEN</p>	<p>LAVE VAISSELLE DISHWASHER Safe</p>	<p>NETTOYAGE FACILE EASY TO CLEAN</p>
---	--------------------	------------------------------------	--------------------------------	--	--	---	---

STAINLESS STEEL / LID - DEEP STEWPAN - STOCKPOT

MADE IN FRANCE



Made in France and Sitram professional ranges' best seller, Pro1 is appreciated for its durability and performances.

FINISH

• High quality 18/10 stainless steel - Matt Inside and outside

ACCESSORIES

- Accessories made of insulated stainless steel and professional hollow handle
- Pouring rim
- Stainless steel F17 lid
- Triple layered sandwich bottom for optimal heat diffusion

LID



REF.	Ø cm	Ø in		REF.	Ø cm	Ø in	
710204	14	5,52	1	710209	26	10,24	1
710205	16	6,30	1	710210	28	11,03	1
710206	18	7,09	1	710211	30	11,82	1
710207	20	7,88	1	710212	34	13,40	1
710208	24	9,46	1	710213	40	15,76	1

HALF STOCKPOT



• with F17 stainless steel lid

REF.	Ø cm	Ø in				
------	------	------	--	--	--	--

WITH LID

710917	16	6,30	2,1 / 2,22	1-2	6	
710308	20	7,88	3,8 / 4,02	2-4	3	
710918	24	9,46	6,4 / 6,76	5-7	1	
710309	28	11,03	10 / 10,56	8-10	1	
710919	30	11,82	13 / 13,73	11-14	1	
710310	34	13,40	18,7 / 19,76	15-20	1	
710920	40	15,76	30 / 31,70	21-30	1	

WITHOUT LID

710180	16	6,30	2,1 / 2,22	1-2	6	
710181	20	7,88	3,8 / 4,02	2-4	3	
710182	24	9,46	6,4 / 6,76	5-7	1	
710183	28	11,03	10 / 10,56	8-10	1	
710184	30	11,82	13 / 13,73	11-14	1	
710185	34	13,40	18,7 / 19,76	15-20	1	
710186	40	15,76	30 / 31,70	21-30	1	

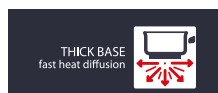

QUALITÉ PROFESSIONNELLE PROFESSIONAL QUALITY 	GAZ GAS 	ÉLECTRICITÉ ELECTRICITY 	INDUCTION INDUCTION 	RÉSISTANCE Spirale COIL ELEMENT 	VITROCERAM Halogène HALOGEN 	LAVE VAISSELLE Safe DISHWASHER Safe 	NETTOYAGE FACILE EASY TO CLEAN
---	----------------	--------------------------------	----------------------------	--	------------------------------------	--	---------------------------------------

DEEP STEWPAN

REF.

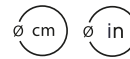

• with F17 stainless steel lid

WITH LID

3 ¹ 108837 ¹ 109273 ¹	710927	20 / 7,88	2,8 / 2,96	2-3	1	
3 ¹ 108830 ¹ 524516 ¹	710338	28 / 11,03	8,3 / 8,77	5-8	1	
3 ¹ 108830 ¹ 524509 ¹	710326	30 / 11,82	10,4 / 10,99	7-11	2	
3 ¹ 108837 ¹ 109280 ¹	710928	34 / 13,40	14 / 14,79	8-14	1	
3 ¹ 108837 ¹ 109297 ¹	710929	40 / 15,76	23,5 / 24,83	15-23	1	

WITHOUT LID



0 ⁰ 52097 ¹ 020096 ¹	710260	16 / 6,30	1,4 / 1,48	1-2	4	
0 ⁰ 52097 ¹ 020102 ¹	710164	20 / 7,88	2,8 / 2,96	2-3	1	
0 ⁰ 52097 ¹ 020409 ¹	710165	24 / 9,46	5,1 / 5,39	4-7	1	
0 ⁰ 52097 ¹ 020454 ¹	710166	26 / 10,24	6,7 / 7,08	4-7	1	
0 ⁰ 52097 ¹ 020430 ¹	710203	28 / 11,03	8,3 / 8,77	5-8	1	
0 ⁰ 52097 ¹ 020423 ¹	710214	30 / 11,82	10,4 / 10,99	7-11	2	
0 ⁰ 52097 ¹ 020416 ¹	710167	34 / 13,40	14 / 14,79	8-14	1	
0 ⁰ 52097 ¹ 020447 ¹	710168	40 / 15,76	23,5 / 24,83	15-23	1	

STOCKPOT



• with F17 stainless steel lid

WITH LID

3 ¹ 108837 ¹ 109242 ¹	710924	24 / 9,46	10,5 / 11,09	7-11	1	
3 ¹ 108830 ¹ 522888 ¹	710311	28 / 11,03	16,5 / 17,43	12-17	1	
3 ¹ 108830 ¹ 522895 ¹	710312	30 / 11,82	21 / 22,19	18-21	1	
3 ¹ 108837 ¹ 109259 ¹	710925	34 / 13,40	30 / 31,70	22-30	1	
3 ¹ 108837 ¹ 109266 ¹	710926	40 / 15,76	50 / 52,83	31-50	1	

WITHOUT LID

0 ⁰ 52097 ¹ 020263 ¹	710198	24 / 9,46	10,5 / 11,09	7-11	1	
0 ⁰ 52097 ¹ 020270 ¹	710199	28 / 11,03	16,5 / 17,43	12-17	1	
0 ⁰ 52097 ¹ 020287 ¹	710200	30 / 11,82	21 / 22,19	18-21	1	
0 ⁰ 52097 ¹ 020294 ¹	710201	34 / 13,40	30 / 31,70	22-30	1	
0 ⁰ 52097 ¹ 020300 ¹	710202	40 / 15,76	50 / 52,83	31-50	1	

MADE IN FRANCE

A professional quality body set off by an unadorned designer handle.

FINISH

- High quality stainless steel 18/10 - Matt inside and outside

ACCESSORIES

- Welded stainless steel parts
- Superlative ergonomics and safety designed into this stainless steel stick handle
- Thick sandwich base for perfect heat distribution



THICK BASE
fast heat diffusion

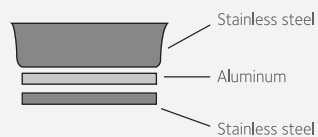

QUALITÉ
PROFESSIONNELLE
PROFESSIONAL
QUALITY



GAZ



GAS

ELECTRICITÉ

ELECTRICITY



INDUCTION

INDUCTION



RÉSISTANCE

Spirale
COIL ELEMENT



VITROCERAM

Halogène
HALOGEN



LAVE

VAISSELLE

DISHWASHER
Safe



NETTOYAGE

FACILE
EASY
TO CLEAN



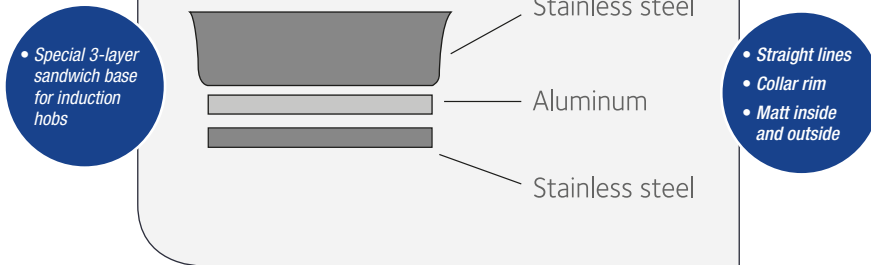

SAUCEPAN

REF.



WITH 2 POURING LIPS

3 ¹ 108830 522802	710304	14 / 5,52	0,9 / 0,95	1	5	
------------------------------	---------------	-----------	------------	---	---	--

NO POURING LIPS

3 ¹ 108830 525377	710333	16 / 6,30	1,4 / 1,48	1-2	5	
------------------------------	---------------	-----------	------------	-----	---	--

3 ¹ 108830 525384	710334	18 / 7,09	2 / 2,11	2-3	5	
------------------------------	---------------	-----------	----------	-----	---	--

3 ¹ 108830 522819	710305	20 / 7,88	2,8 / 2,96	3-4	5	
------------------------------	---------------	-----------	------------	-----	---	--

3 ¹ 108830 525414	710335	24 / 9,46	5,1 / 5,39	4-5	4	
------------------------------	---------------	-----------	------------	-----	---	--

FRYING PAN



3 ¹ 108830 525391	710336	20 / 7,88	1,2 / 1,27	1-2	3	
------------------------------	---------------	-----------	------------	-----	---	--

3 ¹ 108830 523649	710320	24 / 9,46	1,7 / 1,80	2-3	3	
------------------------------	---------------	-----------	------------	-----	---	--

3 ¹ 108830 522826	710306	28 / 11,03	2,5 / 2,64	3-4	3	
------------------------------	---------------	------------	------------	-----	---	--

SAUTE PAN



3 ¹ 108830 522840	710307	24 / 9,46	3,1 / 3,28	2-4	4	
------------------------------	---------------	-----------	------------	-----	---	--

3 ¹ 108830 525407	710337	28 / 11,03	4,6 / 4,86	4-6	3	
------------------------------	---------------	------------	------------	-----	---	--

MADE IN FRANCE

A practical, user-friendly range of accessories for everyday use in your kitchen.



MATERIAL

- 18/10 Stainless steel
- Three-layer non-warp high diffusion SS/AL/SS sandwich base

ACCESSORIES

- Welded stainless steel handles
- Stainless steel insulating equipment
- Stainless steel lid



GAZ



GAZ

ELECTRICITÉ



ELECTRICITY

INDUCTION



INDUCTION

RÉSISTANCE

Spirale



COIL
ELEMENT

VITROCERAM

Halogène

HALOGEN



LAVE

VAISSELLE

DISHWASHER

Safe



NETTOYAGE

FACILE

EASY
TO CLEAN



PASTA COOKER

REF. ∅ cm ∅ in L qt



710611 24 / 9,46 6,8 / 7,18 / 1



• Stainless steel lid

- Stainless steel
- Base 4.5mm - Body 1.5mm
- Welded stainless steel handles

STOCKPOT



710825 24 / 9,46 10,5 / 11,09 / 2



• Stainless steel lid

SAUCEPAN



710826 14 / 5,52 / 1 5



710827 16 / 6,30 / 1-2 5



710828 18 / 7,09 / 2-3 5



GAZ	ELECTRICITÉ	INDUCTION	RÉSISTANCE Spirale	VITROCERAM Halogène	LAVE VAISSELLE	NETTOYAGE FACILE
GAS	ELECTRICITY	INDUCTION	COIL ELEMENT	HALOGEN	DISHWASHER Safe	EASY TO CLEAN

MADE IN FRANCE



Ideal for roasting, simmering and browning meat and fish.

MATERIAL

- 3-layer Quantum non-stick coating
- Shiny stainless steel outside, satin finish inside

ACCESSORIES

- Heat-resistant SoftTouch handle and grips



THICK BASE
fast heat diffusion



GAZ



GAZ

ELECTRICIT 



ELECTRICITY

INDUCTION



INDUCTION

R SISTANCE

Spirale

COIL ELEMENT



VITROCERAM

Halog ne

HALOGEN



LAVE

VAISSELLE

DISHWASHER Safe



NETTOYAGE

FACILE















EASY TO CLEAN



SAUCEPAN

	REF.	∅ cm	∅ in			
	 710266	14	5,52	1	5	
	 710267	16	6,30	1-2	5	
	 710268	18	7,09	2-3	5	
	 710269	20	7,88	3-4	5	

FRYING PAN

	 710270	20	7,88	1-2	6	
	 710271	24	9,46	2-3	6	
	 710272	28	11,03	3-4	6	
	 710273	20	7,88	1-2	6	
	 710274	24	9,46	2-3	6	
	 710275	28	11,03	3-4	6	

WOK

	 710276	28	11,03	4-6	4	
						

SAUTE PAN

	 710286	24	9,46	2-4	4	
						

DEEP STEWPOT

	 710285	24	9,46	4-6	4	
						

GAZ 	ELECTRICITÉ 	INDUCTION 	RÉSISTANCE Spirale COIL ELEMENT 	VITROCERAM Halogène HALOGEN 	LAVE VAISSELLE Dishwasher Safe 	NETTOYAGE FACILE EASY TO CLEAN 
---	---	---	---	--	--	--

Une série professionnelle complète, au polissage brillant,
qui regroupe à la fois haute qualité et élégance.
A large professional range which integrates quality and elegance.

FINITION/FINISH

- Intérieur mat et extérieur miroir
Matt interior and mirror exterior

ACCESSOIRES/ACCESSORIES

- Poignées et anses soudées en inox / *Welded stainless steel handles*
- Poignée tube pour une prise en main facile / *Tubular handle for easy grip*
- Couvercle inox / *Stainless steel lid*
- Fond sandwich triple épaisseur pour une diffusion optimale de la chaleur
Triple layered sandwich bottom for optimal heat diffusion

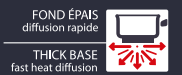

QUALITÉ
PROFESSIONNELLE
PROFESSIONAL
QUALITY



GAZ



GAS

ELECTRICITÉ
ELECTRICITY



INDUCTION
INDUCTION



RÉSISTANCE
Spirale
COIL ELEMENT



VITROCERAM
Halogène
HALOGEN



LAVE
VAISSELLE
DISHWASHER
Safe



NETTOYAGE
FACILE
EASY
TO CLEAN



INOX / STAINLESS STEEL

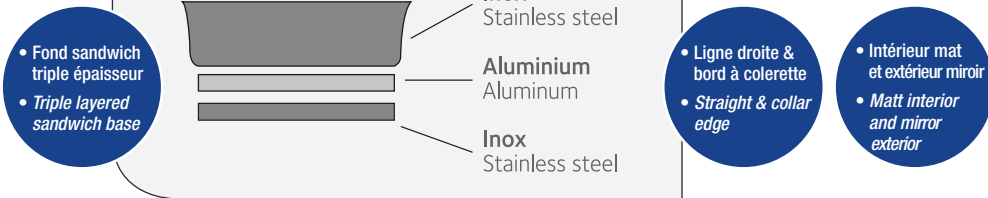

CASSEROLE / SAUCEPAN



REF.

∅ cm

∅ in

L

qt



3 108837 105220

710522

12 / 4,73

1 / 1,06

1

6

3 108830 522291

710389

14 / 5,52

1 / 1,06

1

6

CASSEROLE / SAUCEPAN



3 108830 527739

710403

20 / 7,88

3 / 3,17

3-4

6

POÊLE REVÊTUE / COATED FRYPAN

ECO RESPONSABLE
Fabriqué sans PFOA



3 108837 105251

710525

20 / 7,88

1-2

6

3 108830 527845

710390

24 / 9,46

2,7 / 2,85

2-3

6

3 108830 527852

710391

28 / 11,03

4 / 4,23

3-4

6

SAUTEUSE / DEEP FRYPAN



3 108830 522352

710406

28 / 11,03

4,6 / 4,86

4-6

4

TRAITEUR / STOCKPOT



3 108830 527746

710404

24 / 9,46

6,4 / 6,76

5-7

2

3 108830 527753

710405

28 / 11,03

12-17

2

QUALITÉ PROFESSIONNELLE PROFESSIONAL QUALITY	GAZ GAS	ELECTRICITÉ ELECTRICITY	INDUCTION	RÉSISTANCE Spirale COIL ELEMENT	VITROCERAM Halogène HALOGEN	LAVE VAISSELLE DISHWASHER Safe	NETTOYAGE FACILE EASY TO CLEAN
---	------------	----------------------------	-----------	------------------------------------	-----------------------------------	-----------------------------------	-----------------------------------

En plus de son élégance, la gamme Sitraprestige apporte confort et hygiène, tout en offrant une diffusion optimale de la chaleur. Une qualité professionnelle au service du particulier.

In addition to its elegance, the range Sitraprestige offers comfort, hygiene, when insuring optimal heat diffusion.

FINITION/FINISH

- Intérieur mat et extérieur miroir
Matt inside and mirror polishing outside

ACCESSOIRES/ACCESSORIES

- Fond et corps 3 plis 2,3 mm - inox/aluminium/inox
Triply 2.3mm bottom and body - stainless steel/alu/stainless steel
- Poignée tube soudée pour une hygiène parfaite
Perfectly hygienic with welded handle
- Grand bord verseur / Large pouring rim



INOX Triply *Tri-ply stainless steel*

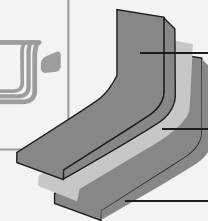

Inox 18/8
Stainless steel

Aluminium
Aluminium

Inox magnétique
18/0
Magnetic
stainless steel

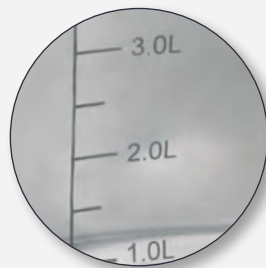

- Fond et corps 3 plis 2,3 mm
- Triply bottom and body

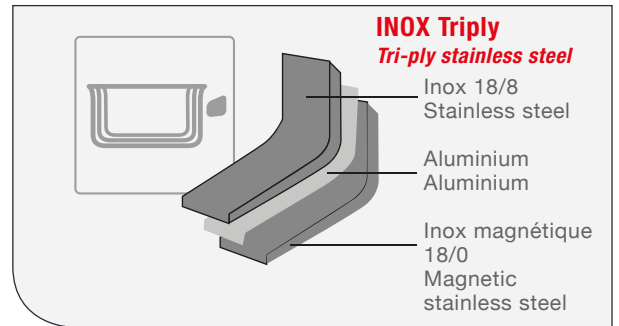

SAUTEUSE CONIQUE / CONICAL SKILLET

REF.



710492

18 / 7,09

1,5 / 1,58

1

4



710493

20 / 7,88

1,8 / 1,90

1-2

4



710494

24 / 9,46

3,3 / 3,49

2-4

4



- Bord verseur
- *Pouring rim*

- Repères litrage intérieurs
- *Graduations*

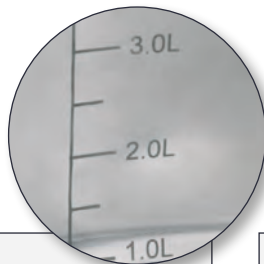

- Poignée tube soudée
- *Welded tubular handle*





Grâce à sa structure intégrale composée de 3 couches, vous obtiendrez une diffusion parfaite et homogène de la chaleur. Une très longue durée de vie et la perfection professionnelle à votre portée.

It's tri-ply construction throughout gives you perfect, even heat diffusion. Very long service life and professional perfection, in your hands.

MATÉRIAU/MATERIAL

- Inox Triply 2 mm / *Tri-ply 2-mm stainless steel*
 - Intérieur satiné, finition extérieure miroir
Satin interior, mirror exterior finishes
- Fond full induction / *Special base for induction hobs*

ACCESSOIRES/ACCESSORIES

- Manche et poignée inox rivetées pour une résistance de professionnel
Stainless steel riveted handle and grips for professional strength



INOX Triply *Tri-ply stainless steel*

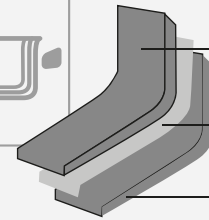

Inox 18/8
Stainless steel

Aluminium
Aluminium

Inox magnétique
18/0
Magnetic
stainless steel



GAZ



GAZ

ELECTRICITÉ



ELECTRICITY

INDUCTION



INDUCTION

RÉSISTANCE

Spirale



COIL
ELEMENT

VITROCERAM

Halogène

HALOGEN



LAVE

VAISSELLE

DISHWASHER
Safe



NETTOYAGE

FACILE

EASY
TO CLEAN





- Manche et poignées rivetés
- Riveted handle and grips

- Inox Triply 2 mm
- Tri-ply 2-mm stainless steel

CASSEROLE / SAUCEPAN

REF.

∅ cm ∅ in

L qt



REF.	∅ cm	∅ in	L	qt	Person	Pan	Box
710728	14	5,52			1	6	
710729	16	6,30			1-2	6	
710730	18	7,09			2-3	6	
710781	20	7,88			3-4	6	

POËLE / FRYING PAN



REF.	∅ cm	∅ in	L	qt	Person	Pan	Box
710731	20	7,88			1-2	6	
710732	24	9,46			2-3	6	
710733	28	11,03			3-4	6	

SAUTEUSE / SAUTE PAN



- avec couvercle vapeur verre
- with glass steam lid

REF.	∅ cm	∅ in	L	qt	Person	Pan	Box
710734	24	9,46			2-4	4	

WOK / WOK



- avec couvercle vapeur verre
- with glass steam lid

REF.	∅ cm	∅ in	L	qt	Person	Pan	Box
710735	28	11,03			4-6	2	

FAITOUT / DEEP STEWPOT



- avec couvercle vapeur verre
- with glass steam lid

REF.	∅ cm	∅ in	L	qt	Person	Pan	Box
710736	20	7,88	2,5	2,64	2-4	4	
710737	24	9,46	5	5,28	4-6	4	

GAZ GAS		ELECTRICITÉ ELECTRICITY		INDUCTION		RÉSISTANCE Spirale COIL ELEMENT		VITROCERAM Halogène HALOGEN		LAVE VAISSELLE DISHWASHER Safe		NETTOYAGE FACILE EASY TO CLEAN	
------------	--	----------------------------	--	-----------	--	--	--	-----------------------------------	--	---	--	---	--

Une exigence de professionnel pour votre cuisine au quotidien.

Professional standard for everyday cooking.

MATÉRIAU/MATERIAL

- Inox brossé intérieur/extérieur
Brushed stainless steel exterior and interior finish
- Fond spécial induction triple épaisseur capsulé 2,5 mm
pour une meilleure stabilité thermique
Special 2.5-mm triple thickness capsule base for better thermal stability

ACCESSOIRES/ACCESSORIES

- Poignées inox rivetées ultra résistantes
Riveted stainless steel handle and grips
- Repères intérieurs litreage / Litre graduation markings inside

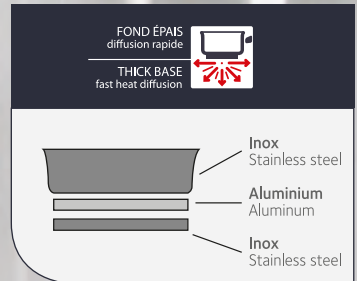

- Poignées rivetées ultra résistantes
- Ultra-strong riveted handles

- Inox brossé int./ ext.
- Brushed stainless steel int./ext.

- Fond capsulé
- Capsulated bottom

FAITOUT / DEEP STEWPOT

REF.

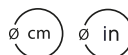

- avec couvercle vapeur verre
- with glass steam lid

3 108837 106869 **710686**

24 / 9,46

4 / 4,23

4-6

4



3 108837 106876 **710687**

28 / 11,03

8 / 8,45

6-8

4



MARMITE / STEWPOT



- avec couvercle vapeur verre
- with glass steam lid

3 108837 106883 **710688**

24 / 9,46

6 / 6,34

4-6

4



3 108837 106890 **710689**

28 / 11,03

10 / 10,56

6-8

4



TRAITEUR / STOCKPOT



- avec couvercle vapeur verre
- with glass steam lid

3 108837 106845 **710684**

24 / 9,46

9 / 9,51

7-11

2



3 108837 106852 **710685**

28 / 11,03

14 / 14,79

12-17

2

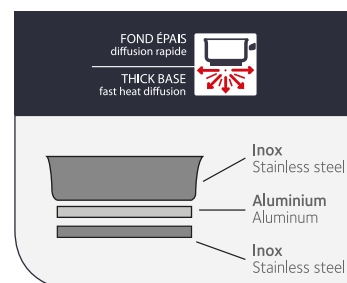

Pour votre cuisine au quotidien, la gamme Harmony vous garantira une diffusion optimale de la chaleur.

The Harmony range guarantees the best heat diffusion for daily cooking.

MATÉRIAU/MATERIAL

- Inox, fond triple épaisseur capsulé 3,5 mm pour une meilleure stabilité thermique
Triple thickness capsulated 3.5mm stainless steel base
- Finition : intérieur miroir - extérieur satiné avec bande miroir
Finishes: mirror interior - satin exterior with mirror band
- Fond spécial induction / *Special base for induction hobs*

ACCESSOIRES/ACCESSORIES

- Manche et poignée inox rivetées pour une meilleure sécurité
Extra-safe riveted handle and grips
- Repères intérieurs litreage / *Litre graduation markings inside*

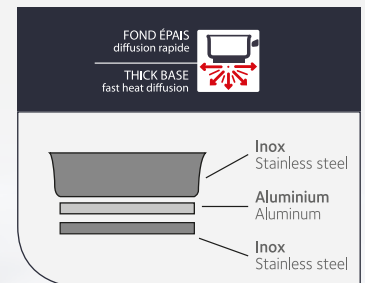
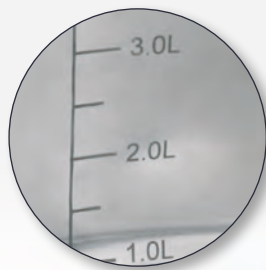

GAZ



GAZ

ELECTRICITÉ



ELECTRICITY

INDUCTION



INDUCTION

RÉSISTANCE

Spirale



COIL ELEMENT

VITROCERAM

Halogène

HALOGEN



LAVE

VAISSELLE

DISHWASHER

Safe



NETTOYAGE

FACILE

EASY TO CLEAN



- Manche et poignées rivetés
- Riveted handle and grips

- Fond capsulé
- Capsulated bottom

CASSEROLE / SAUCEPAN

REF.



710647

16 / 6,30

1-2

6



710648

18 / 7,09

2-3

6



710649

20 / 7,88

3-4

6



POËLE / FRYING PAN



710655

24 / 9,46

2-3

6



710656

26 / 10,24

2-3

6



710657

28 / 11,03

3-4

6



SAUTEUSE / SAUTE PAN



- avec couvercle vapeur verre
- with glass steam lid



710650

24 / 9,46

2-4

6



MARMITE / STEWPOT



- avec couvercle vapeur verre
- with glass steam lid



710651

24 / 9,46

6 / 6,34

4-6

4



710652

28 / 11,03

10 / 10,56

6-8

4



TRAITEUR / STOCKPOT



- avec couvercle vapeur verre
- with glass steam lid



710653

24 / 9,46

9 / 9,51

7-11

2



710654

28 / 11,03

14 / 14,79

12-17

2



GAZ



ELECTRICITÉ



INDUCTION



RÉSISTANCE

Spirale
COIL
ELEMENT



VITROCERAM

Halogène
HALOGEN



LAVE

VAISSELLE
DISHWASHER
Safe



NETTOYAGE

FACILE
EASY
TO CLEAN





Avec la gamme Charleston, la cuisson allie esthétique et efficacité.
Cooking with the Charleston range combines stylishness and efficiency.

MATÉRIAU/MATERIAL

- Inox brossé intérieur, extérieur blanc
Brushed stainless steel inside, black outside
- Fond spécial induction triple épaisseur capsulé 4,3 mm pour une meilleure stabilité thermique
Special triply 4.3-mm capsulated base for induction hobs enhances thermal stability

ACCESSOIRES/ACCESSORIES

- Manche et poignée inox rivetées pour une meilleure sécurité
Riveted stainless steel handle and grips for extra safety
- Repères intérieurs litreage / Litre graduation markings inside

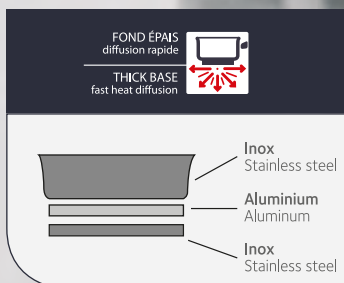



- Manche et poignées inox rivetés
- Riveted stainless steel handle and grips

- Inox brossé intérieur, extérieur noir
- Brushed stainless steel inside, black outside

CASSEROLE / SAUCEPAN

REF.



710641

16 / 6,30

1-2

6



710642

18 / 7,09

2-3

6



710643

20 / 7,88

3-4

6



SAUTEUSE / SAUTE PAN



- avec couvercle vapeur verre
- with glass steam lid



710646

24 / 9,46

2-4

4



FAITOUT / DEEP STEWPOT



- avec couvercle vapeur verre
- with glass steam lid



710644

20 / 7,88

3 / 3,17

2-4

6



710645

24 / 9,46

5,5 / 5,81

4-6

4



- Fond sandwich triple épaisseur spécial induction
- Special triple-layer base for induction hobs

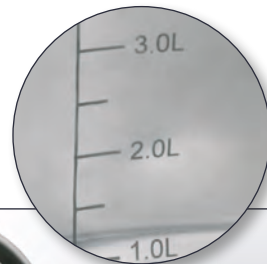
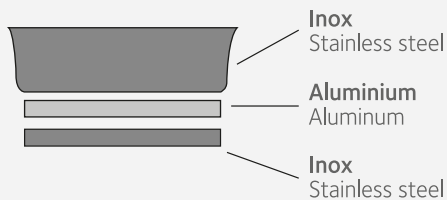

Repères intérieurs litrage
Litre graduation markings inside



GAZ



GAZ

ELECTRICITÉ



ELECTRICITY

INDUCTION



INDUCTION

RÉSISTANCE



Spirale
COIL
ELEMENT

VITROCERAM



Halogène
HALOGEN

LAVE



VAISSSELLE
DISHWASHER
Safe

NETTOYAGE



FACILE
EASY
TO CLEAN



Avec la gamme Charleston, la cuisson allie esthétique et efficacité.
Cooking with the Charleston range combines stylishness and efficiency.

MATÉRIAU/MATERIAL

- Inox brossé intérieur, extérieur blanc
Brushed stainless steel inside, white outside
- Fond spécial induction triple épaisseur capsulé 4,3 mm pour une meilleure stabilité thermique
Special triply 4.3-mm capsulated base for induction hobs enhances thermal stability

ACCESSOIRES/ACCESSORIES

- Manche et poignée inox rivetées pour une meilleure sécurité
Riveted stainless steel handle and grips for extra safety
- Repères intérieurs litreage / Litre graduation markings inside



FOND ÉPAIS
diffusion rapide



THICK BASE
fast heat diffusion

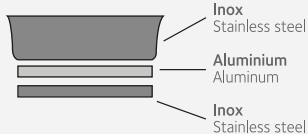

GAZ



GAZ

ELECTRICITÉ



ELECTRICITY

INDUCTION



INDUCTION

RÉSISTANCE

Spirale



COIL
ELEMENT

VITROCERAM

Halogène

HALOGEN



LAVE

VAISSELLE

DISHWASHER

Safe



NETTOYAGE

FACILE

EASY
TO CLEAN





- Manche et poignées inox rivetés
- Riveted stainless steel handle and grips

- Inox brossé intérieur Extérieur blanc
- Brushed stainless steel inside, white outside

CASSEROLE / SAUCEPAN

REF.

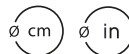

710635

16 / 6,30

1-2

6



710636

18 / 7,09

2-3

6



710637

20 / 7,88

3-4

6



SAUTEUSE / SAUTE PAN



- avec couvercle vapeur verre
- with glass steam lid



710640

24 / 9,46

2-4

4



FAITOUT / DEEP STEWPOT



- avec couvercle vapeur verre
- with glass steam lid



710638

20 / 7,88

3 / 3,17

2-4

6



710639

24 / 9,46

5,5 / 5,81

4-6

4



- Fond sandwich triple épaisseur spécial induction
- Special triple-layer base for induction hobs

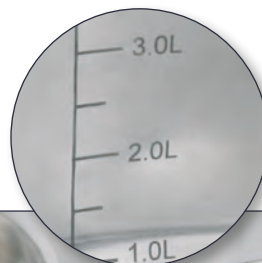
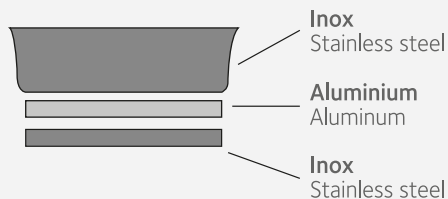

Repères intérieurs litre
Litre graduation markings inside



GAZ



GAZ

ELECTRICITÉ



ELECTRICITY

INDUCTION



INDUCTION

RÉSISTANCE



COIL ELEMENT

VITROCERAM



HALOGEN

LAVE



DISHWASHER Safe

NETTOYAGE FACILE



EASY TO CLEAN

SITRAM SYMPHONY Color

INOX / STAINLESS STEEL



Sitram offre une touche d'éclat et rafraîchit votre cuisine grâce à la gamme glam et ultra select Symphony Color.
 Sitram offers your kitchen a refreshing sparkle to your kitchen with the glamorous, ultra-select Symphony Color range.

MATÉRIAU/MATERIAL

- Revêtement 3 couches premium breveté Select par Teflon® anti-abrasif, anti-rayure et sain (sans PFOA)
Premium patented Select 3-layer coating by Teflon® that is abrasion-, scratch-resistant and healthy (w/o PFOA)
- Inox brossé extérieur finition satinée, intérieur couleur
Brushed satin stainless steel exterior finish, coloured interior
- Fond spécial induction triple épaisseur capsulé 3,5 mm
Special 3.5-mm triple thickness capsule base for induction hobs
- Répartition optimale de la chaleur / Perfect heat distribution

ACCESSOIRES/ACCESSORIES

- Manche et poignée inox rivetés pour une meilleure sécurité
Extra-safe riveted handle and grips



Intérieur disponible en 4 coloris (Interior comes in 4 colourways) : Lavander blue / Champagne gold / Purple / Hot chilli

SAUTEUSE / SAUTE PAN



- avec couvercle vapeur verre
- with glass cover lid

REF.	∅ cm	∅ in		
3 108837 110453 711045	24	9,46	2-4	4
3 108837 110101 711010	28	11,03	4-6	4
3 108837 110422 711042	24	9,46	2-4	4
3 108837 110149 711014	28	11,03	4-6	4
3 108837 110446 711044	24	9,46	2-4	4
3 108837 110224 711022	28	11,03	4-6	4
3 108837 110439 711043	24	9,46	2-4	4
3 108837 110187 711018	28	11,03	4-6	4

FAITOUT / DEEP STEWPOT



- avec couvercle vapeur verre
- with glass cover lid

3 108837 110262 711026	24	9,46	4-6	2
3 108837 110323 711032	24	9,46	4-6	2
3 108837 110415 711041	24	9,46	4-6	2
3 108837 110361 711036	24	9,46	4-6	2

GAZ GAS	ELECTRICITÉ ELECTRICITY	INDUCTION	RÉSISTANCE Spirale COIL ELEMENT	VITROCERAM Halogène HALOGEN	LAVE VAISSELLE DISHWASHER Safe	NETTOYAGE FACILE EASY TO CLEAN
------------	----------------------------	-----------	------------------------------------	--------------------------------	-----------------------------------	-----------------------------------

Teflon® est une marque déposée de DuPont et utilisée sous licence.
 Teflon® is a registered trademark of DuPont used under licence.

POÊLE / FRYING PAN



	REF.	∅ cm	∅ in		
	711011 3 ¹ 108837 ¹ 110118	20	7,88	1-2	6
	711012 3 ¹ 108837 ¹ 110125	24	9,46	2-3	6
	711013 3 ¹ 108837 ¹ 110132	28	11,03	3-4	6
	711015 3 ¹ 108837 ¹ 110156	20	7,88	1-2	6
	711016 3 ¹ 108837 ¹ 110163	24	9,46	2-3	6
	711017 3 ¹ 108837 ¹ 110170	28	11,03	3-4	6
	711023 3 ¹ 108837 ¹ 110231	20	7,88	1-2	6
	711024 3 ¹ 108837 ¹ 110248	24	9,46	2-3	6
	711025 3 ¹ 108837 ¹ 110255	28	11,03	3-4	6
	711019 3 ¹ 108837 ¹ 110194	20	7,88	1-2	6
	711020 3 ¹ 108837 ¹ 110200	24	9,46	2-3	6
	711021 3 ¹ 108837 ¹ 110217	28	11,03	3-4	6

CASSEROLE / SAUCEPAN



	711027 3 ¹ 108837 ¹ 110279	16	6,30	1-2	6
	711028 3 ¹ 108837 ¹ 110286	18	7,09	2-3	6
	711037 3 ¹ 108837 ¹ 110378	20	7,88	3-4	6
	711029 3 ¹ 108837 ¹ 110293	16	6,30	1-2	6
	711030 3 ¹ 108837 ¹ 110309	18	7,09	2-3	6
	711031 3 ¹ 108837 ¹ 110316	20	7,88	3-4	6
	711038 3 ¹ 108837 ¹ 110385	16	6,30	1-2	6
	711039 3 ¹ 108837 ¹ 110392	18	7,09	2-3	6
	711040 3 ¹ 108837 ¹ 110408	20	7,88	3-4	6
	711033 3 ¹ 108837 ¹ 110330	16	6,30	1-2	6
	711034 3 ¹ 108837 ¹ 110347	18	7,09	2-3	6
	711035 3 ¹ 108837 ¹ 110354	20	7,88	3-4	6

Cuisinez sainement avec la gamme Symphony Ceram.
Cook healthily with the Symphony Ceram range.

MATÉRIAU/MATERIAL

- Revêtement à base de céramique / *Ceramic based coating*
- Finition extérieure inox satiné / *Satin stainless steel exterior finish*
 - Fond spécial induction / *Special base for induction hobs*
 - Diffusion optimale de la chaleur / *Perfect heat distribution*

ACCESSOIRES/ACCESSORIES

- Corps et manche inox rivetés pour une meilleure sécurité
Extra-safe stainless steel riveted body and handle



GAZ



GAZ

ELECTRICITÉ



ELECTRICITY

INDUCTION



INDUCTION

RÉSISTANCE

Spirale

COIL

ELEMENT



VITROCERAM

Halogène

HALOGEN



LAVE

VAISSELLE

DISHWASHER

Safe



NETTOYAGE

FACILE

EASY

TO CLEAN





POÊLE / FRYING PAN



REF.



711003

20 / 7,88

1-2

6



711004

24 / 9,46

2-3

6



711005

28 / 11,03

3-4

6

LOT DE 2 POÊLES / SET OF 2 FRYING PANS



711009

24+28 / 9,46+11,03

2-4

6

- Forme bombée / *Curved shape*
- Revêtement intérieur à base de céramique crème 2 couches sans PFOA
Cream-coloured 2-layer ceramic-based PFOA-free interior coating
- Finition extérieure inox satiné / *Satin stainless steel outside finish*
- Epaisseur corps 0.7 mm / *Body 0.7-mm thick*
- Epaisseur fond 3.5 mm / *Base 3.5-mm thick*
- Avec manche en inox riveté / *Riveted stainless steel handle*

SAUTEUSE / SAUTE PAN



- avec couvercle vapeur verre
- with glass steam lid



711006

24 / 9,46

2-4

4



711007

28 / 11,03

2-4

4

- Corps et manche inox
- *Stainless steel body and handle*



GAZ



ELECTRICITÉ



INDUCTION



RÉSISTANCE

Spirale
COIL
ELEMENT



VITROCERAM

Halogène
HALOGEN



LAVE

VAISSELLE
DISHWASHER
Safe



NETTOYAGE

FACILE
EASY
TO CLEAN





VITAMINEUR / VITAMIN SAVER

REF.



- avec panier vapeur
- with steam basket



710291

22 / 8,67

6 / 6,34

4



- Cuisson vapeur basse pression (cuisson sécurisée)
Low-pressure, pressure cooker (safe cooking)
- Préservation des vitamines et des qualités énergétiques des aliments
Vitamins and food energy content qualities saved
- Ouverture facile / *Easy to open*
- Poignée coulissante thermorésistante / *Heat-resistant sliding handle*
- Repères litrages intérieurs / *Litre graduation markings inside*

CUIT-PÂTES / PASTA COOKER



- avec couvercle
- with lid



710484

24 / 9,46

2



- Inox 18/8 / *18/8 stainless steel*
- Fond 4,1 mm / *4.1 mm base*
- Poignées inox rivetées / *Welded stainless steel grips*

GAZ



ELECTRICITÉ



INDUCTION



RÉSISTANCE

Spirale



VITROCERAM

Halogène



LAVE

VAISSELLE



NETTOYAGE

FACILE



COUSCOUSSIER / COUSCOUS MAKER

REF.



- avec couvercle verre
- with glass lid



710082

25 / 9,85

8 / 8,45

4



- Inox 14/4 / 14/4 stainless steel
- Intérieur satiné, extérieur miroir / Satin interior and mirror exterior finishes
- Fond 3,8 mm / 3.8-mm base
- Poignées inox soudées / Welded stainless steel grips



- avec couvercle inox
- with stainless steel lid



710486

23,5 / 9,06

10 / 10,56

2



- Inox 18/8 / 18/8 stainless steel
- Intérieur satiné, extérieur miroir / Satin interior and mirror exterior finishes
- Fond 4,5 mm / 4.5-mm base
- Poignées thermorésistantes / Heat-resistant grips

CASSEROLES «FIRST» - LOT DE 4 / «FIRST» SAUCEPANS - SET OF 4



710482

14-16-18-20
5,52-6,30-7,09-7,88

4



- Epaisseur corps : 0,5 mm / Body 0.5-mm thick
- Epaisseur fond : 2,5 mm / Base 2.5-mm thick
- Manche thermorésistant soudé noir / Welded heat-resistant black handle

CUIT-VAPEUR / STEAMER



710090

16-20 / 6,30-7,88

2,8 / 2,96

2



710089

20-24 / 7,88-9,46

5 / 5,28

2



- Poignées thermorésistantes soudées / Welded heat-resistant grips

COMBINÉ-VAPEUR «EASTAR» / «EASTAR» STEAMER SAUCEPAN



- avec couvercle verre
- with glass lid



710259

24 / 9,46

5,4 / 5,71

2



- Inox 14/4 / 14/4 stainless steel
- Intérieur et extérieur miroir / Mirror interior and exterior finish
- Corps 0,6 mm / Body 0.6-mm thick
- Fond 2,6 mm / 2.6-mm base thick
- Poignées thermorésistantes / Heat-resistant grips

GAZ
GAS



ELECTRICITÉ
ELECTRICITY



INDUCTION
INDUCTION



RÉSISTANCE
Spirale
COIL
ELEMENT



VITROCERAM
Halogène
HALOGEN



LAVE
VAISSELLE
DISHWASHER
Safe



NETTOYAGE
FACILE
EASY
TO CLEAN



Des lots d'ustensiles et d'accessoires en parfaite complémentarité pour une cuisine maline et efficace.

Complementing utensil and accessory sets for clever, efficient cooking.



AUTOCUISEUR 8L + BOCAUX / 8 L PRESSURE COOKER + JARS

REF.



710845

24 / 9,46

8 / 8,45

1



- Autocuiseur gamme Sitraforza / *Sitraforza pressure cooker range*
- Poignée thermorésistante clipsée / *Clip-on heat-resistant handle*
- Inox finition intérieure satinée / *Stainless steel satin interior finish*
- Cuve inox / *Stainless steel body*
- 3 bocaux Le Parfait de 0,75 ml / *3 Le Parfait 0.75-ml jars*
- Vendu avec 1 livret de recettes / *Comes with a recipe booklet*
- Fabrication française / *French-manufactured*

AUTOCUISEUR 8L + CUVE 4L / 8 L PRESSURE COOKER



710088

24 / 9,46

8 / 8,45 + 4 / 4,23

1



- Autocuiseur gamme Sitraforza / *Sitraforza pressure cooker range*
- Poignée thermorésistante clipsée / *Clip-on heat-resistant handle*
- Inox finition intérieure satinée / *Stainless steel satin interior finish*
- Cuve inox / *Stainless steel body*
- Vendu avec 1 livret de recettes / *Comes with a recipe booklet*
- Fabrication française / *French-manufactured*

GAZ



GAS

ELECTRICITÉ



ELECTRICITY

INDUCTION



INDUCTION

RÉSISTANCE

Spirale



COIL ELEMENT

VITROCERAM

Halogène



HALOGEN

LAVE

VAISSELLE



DISHWASHER Safe

NETTOYAGE

FACILE



EASY TO CLEAN

REF.



AUTOCUISEUR 8L + PANIER + COUVERCLE VERRE / 8 L PRESSURE COOKER + BASKET + GLASS LID



711049

24 / 9,46

8 / 8,45

1

- Inox finition intérieure satinée / *Stainless steel satin interior finish*
- Couverture vapeur en verre / *Glass steam lid*
- Panier vapeur / *Steaming basket*
- Autocuiseur Forza / *Forza pressure cooker*



711051

24 / 9,46

8 / 8,4

1

- Autocuiseur gamme Sitraspeedo / *Sitraspeedo pressure cooker range*
- Inox finition intérieure satinée / *Stainless steel satin interior finish*
- Couverture vapeur en verre / *Glass steam lid*
- Panier vapeur / *Steaming basket*
- Minuteur / *Timer*

AUTOCUISEUR 8L + CUIT-VAPEUR + PANIER + COUVERCLE / 8 L PRESSURE COOKER + STEAMER + BASKET + LID



711050

24 / 9,46

8 / 8,4

1

- Autocuiseur gamme Sitraforza / *Sitraforza pressure cooker range*
- Couverture vapeur en verre Ø24 cm / *Glass steam lid*
- Panier vapeur / *Steaming basket*
- Cuit-vapeur avec couvercle inox Ø26 cm / *Steamer with stainless steel lid*



711052

24 / 9,46

8 / 8,4

1

- Autocuiseur gamme Sitraspeedo / *Sitraspeedo pressure cooker range*
- Couverture vapeur en verre Ø24 cm / *Glass steam lid*
- Panier vapeur / *Steaming basket*
- Cuit-vapeur avec couvercle inox Ø26 cm / *Steamer with stainless steel lid*
- Minuteur / *Timer*

GAZ



GAZ

ELECTRICITÉ



ELECTRICITY

INDUCTION



INDUCTION

RÉSISTANCE

Spirale

COIL ELEMENT



VITROCERAM

Halogène

HALOGEN



LAVE

VAISSELLE

DISHWASHER

Safe



NETTOYAGE

FACILE

EASY TO CLEAN



ALUMINIUM



French Durable Professional



VIP PEPPER

FONTE D'ALUMINIUM - CAST ALUMINIUM



Revêtement
ANTI-ADHÉSIF
★ ★ ★
NON STICK
Coating

ECO RESPONSABLE
Fabriqué
sans
PFOA



TOUS FEUX DONT INDUCTION
ALL HOB INCLUDING INDUCTION



Pour une utilisation facile au quotidien. Idéal pour rôtir, mijoter et faire revenir viandes et poissons.

For everyday cooking. Ideal for roasting, simmering and browning meat and fish.

MATÉRIAU / MATERIAL

Fonte d'aluminium
Cast aluminium

REVÊTEMENT / COATING

Revêtement intérieur Whiteford Xylan 2 couches
2-layer Whiteford Xylan coating

ACCESSOIRES / FITMENTS

Manche et poignée thermorésistants SoftTouch
SoftTouch heat-resistant handle and grips
Couvercle verre
Glass lid



FOND ÉPAIS
diffusion rapide
THICK BASE
fast heat diffusion



SITRAM

VIP PEPPER

FONTES D'ALUMINIUM - CAST ALUMINIUM

POÊLE / FRYING PAN

REF.



711078

20 7,88

1-2 6



711079

24 9,46

2-3 6



711080

26 10,24

2-3 6



711081

28 11,03

3-4 6

SAUTEUSE / SAUTE PAN



711082

24 9,46

2-4 4





FINITION/FINISH
 • Revêtement antiadhérent 2 couches Whitford sans PFOA
 2-layer Whitford non-stick coating PFOA free

- ACCESSOIRES/ACCESSORIES**
- Fond induction / *Special base for induction hobs*
 - Poignée thermorésistante SoftTouch ergonomique
Ergonomic SoftTouch heat-resistant handle
 - Couvercle en verre avec bouton thermorésistant SoftTouch
Glass lid with heat-resistant SoftTouch knob

Pour une utilisation facile au quotidien.
 Idéal pour rôtir, mijoter et faire revenir viandes et poissons.
For everyday cooking. Ideal for roasting, simmering and browning meat and fish.



GRILL / GRIL

REF.



710413

28x28 / 11,03x11,03

5,3 / 5,60

2-3

6



WOK / WOK



- Avec couvercle vapeur en verre
- With glass steam lid



710401

32 / 12,61

5,3 / 5,60

4-5

4



	REF.	∅ cm	∅ in	L	qt	Personne	Boîte
--	------	------	------	---	----	----------	-------

CASSEROLE AVEC BEC VERSEUR / SAUCEPAN WITH POURING RIM



	710407	16 / 6,30		1,3 / 1,37		1-2	6
	710408	18 / 7,09		1,6 / 1,69		2-3	6
	710409	20 / 7,88		2,3 / 2,43		3-4	6

LOT DE 3 CASSEROLLES / 3-PIECE SAUCEPAN SET

	710399	16-18-20 / 6,30-7,09-7,88		1,3 > 2,3 / 1,37 to 2,43		1-3	4
--	---------------	------------------------------	--	-----------------------------	--	-----	---

POËLE / FRYING PAN



	710410	20 / 7,88		1,2 / 1,27		1-2	6
	710411	24 / 9,46		1,7 / 1,80		2-3	6
	711061	26 / 10,24				3-4	6
	710412	28 / 11,03		2,9 / 3,06		3-4	6
	711062	30 / 11,82				4-5	6

LOT DE 3 POÊLES / 3-PIECE FRYPAN SET

	710400	20-24-28 / 7,88-9,46-11,03		1,2 à 2,9 / 1,27 to 3,06		1-4	4
--	---------------	-------------------------------	--	-----------------------------	--	-----	---

CRÊPIÈRE / PANCAKE PAN



	LIVRÉE AVEC RÉPARTITEUR BOIS						
	710451	30 / 11,82					6
	SANS RÉPARTITEUR						
	711063	30 / 11,82					6

SAUTEUSE / SAUTE FRYPAN



	710398	28 / 11,03		3,4 / 3,59		4-6	4
--	---------------	------------	--	------------	--	-----	---

FAITOUT / DEEP STEWPOT



	710500	24 / 9,46		5,4 / 5,71		4-5	4
	710397	28 / 11,03		6,7 / 7,08		6-8	4

Pour une utilisation facile au quotidien.
 Idéal pour rôtir, mijoter et faire revenir viandes et poissons.
For everyday cooking. Ideal for roasting, simmering and browning meat and fish.



FINITION/FINISH

- Revêtement intérieur Whiteford Xylan 2 couches
2-layer Whiteford Xylan coating

ACCESSOIRES/ACCESSORIES

- Fond induction 4,7 mm / *Special 4.7mm base for induction hobs*
- Manche et poignée thermorésistants SoftTouch
SoftTouch heat-resistant handle and grips



ROASTER / ROASTER

REF.



710402 40,5x26 / 15,76x10,24 / / 4

WOK / WOK



- Avec couvercle en verre
- With glass lid



710219 32 / 12,61 5 / 5,28 5-7 4



CASSEROLE / SAUCEPAN



- Poignée thermorésistante SoftTouch
- SoftTouch heat-resistant handle

REF.

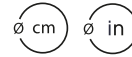

REF.	Ø cm	Ø in	L	qt	Person	Box	Color
3 ¹ 108830 516269 710251	16	6,30	1,3	1,37	1-2	6	Black
3 ¹ 108830 516276 710252	18	7,09	1,7	1,80	2-3	6	Black
3 ¹ 108830 516283 710253	20	7,88	2,3	2,43	3-4	6	Black

POÊLE / FRYING PAN



- Poignée thermorésistante SoftTouch
- SoftTouch heat-resistant handle

3 ¹ 108830 514999 710254	20	7,88	1	1,06	1-2	6	Black
3 ¹ 108830 515002 710255	24	9,46	1,5	1,58	2-3	6	Black
3 ¹ 108830 516252 710256	26	10,24	2	2,11	2-3	6	Black
3 ¹ 108830 515019 710257	28	11,03	2,8	2,96	3-4	6	Black

LOT DE 3 POÊLES / 3-PIECE FRYING PAN SET



3 ¹ 108830 514531 710216	20- 24-28	7,88-9,46-11,03	1-2,8 / 1,06-2,96	1-4	4	Black
--	-----------	-----------------	-------------------	-----	---	-------

CRÊPIÈRE / PANCAKE PAN



3 ¹ 108830 515026 710239	30	11,82	/	/	6	Black
--	----	-------	---	---	---	-------

SAUTEUSE / SAUTE PAN



- Avec couvercle en verre
- With glass lid

3 ¹ 108830 514500 710218	24	9,46	2,8	2,96	2-4	4	Black
--	----	------	-----	------	-----	---	-------

FAITOUT / DEEP STEWPOT



- Avec couvercle en verre
- With glass lid

3 ¹ 108830 514517 710217	24	9,46	4,3	4,65	4-6	4	Black
--	----	------	-----	------	-----	---	-------

FOND ÉPAIS diffusion rapide THICK BASE fast heat diffusion	GAZ GAS	ELECTRICITÉ ELECTRICITY	INDUCTION	RÉSISTANCE Spirale ELECTRIC COIL	VITROCERAM Halogène CERAMIC Halogen	LAVE VAISSELLE DISHWASHER Safe	NETTOYAGE FACILE EASY TO CLEAN
---	------------	----------------------------	-----------	---	--	---	---



Cuisinez sainement avec le faitout Castro !
Castro dutch oven ensures healthy cooking!

MATÉRIAU/MATERIAL

Revêtement à base de céramique sans PFOA
Healthy ceramic base coating PFOA free

Corps épais indéformable mais léger en fonte d'aluminium
Thick undeformable but lightweight cast aluminium body

ACCESSOIRES/ACCESSORIES

- Fond spécial induction / *Special base for induction hobs*
 - Anses en silicone antidérapantes
Anti-slip silicone handles
- Couvercle verre avec bouton en silicone ergonomique pour poser l'ustensile de cuisine
Glass lid with ergonomic silicone knob to hold kitchen tools





FAITOUT / DEEP STEWPOT

REF.



710478

24 / 9,46

4 / 4,23

4-6

4



710469

28 / 11,03

6,5 / 6,87

6-8

4



- Couvercle en verre bordure silicone
- Glass lid silicone border

- Bouton ergonomique en silicone
- Ergonomic silicon knob

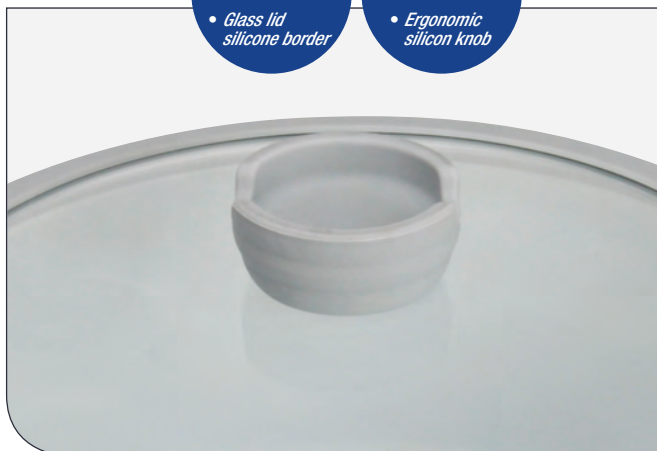

- Accessoires en silicone
- Silicon accessories



GAZ
GAS



ELECTRICITÉ
ELECTRICITY



INDUCTION
INDUCTION



RÉSISTANCE Spirale
COIL ELEMENT



VITROCERAM Halogène
HALOGEN



LAVE VAISSELLE
DISHWASHER Safe



NETTOYAGE FACILE
EASY TO CLEAN



Une cocotte façon «grand-mère» ultra légère idéale pour rôtir, mijoter et faire revenir viandes et poissons.

This «grandma» stewpot is lightweight and ideal to cook and to brown meat or fish.

MATÉRIAU/MATERIAL

Revêtement anti-adhérent haute qualité sans PFOA
High-quality non-stick coating PFOA free

FINITION/FINISH

Peinture noire haute résistance thermique
Black heat resistant painting

ACCESSOIRES/ACCESSORIES

- Fond plein induction / *Full base for induction hobs*
- Poignée et bouton de couvercle en fonte d'aluminium avec cache en silicone amovible

Cast aluminium handle and knob with removable silicone accessories



FOUR



OVEN

GAZ



GAS

ELECTRICITÉ



ELECTRICITY

INDUCTION



INDUCTION

RÉSISTANCE



COIL ELEMENT

VITROCÉRAM



HALOGEN

LAVE



DISHWASHER

Safe

NETTOYAGE



EASY

TO CLEAN



FAITOUT NOIR / BLACK STEWPOT



REF.	∅ cm	∅ in	L	qt	Person	Box
------	------	------	---	----	--------	-----

3 ¹ 108830 ¹ 529931	710392	24 / 9,46	4 / 4,23	4-6	4	
---	---------------	-----------	----------	-----	---	--

3 ¹ 108830 ¹ 529948	710521	28 / 11,03	6,5 / 6,87	6-8	2	
---	---------------	------------	------------	-----	---	--

FAITOUT ASPECT PIERRE / STONE ASPECT STEWPOT



3 ¹ 108830 ¹ 531668	710468	24 / 9,46	4 / 4,23	4-6	4	
---	---------------	-----------	----------	-----	---	--

3 ¹ 108830 ¹ 531644	710465	28 / 11,03	6,5 / 6,87	6-8	4	
---	---------------	------------	------------	-----	---	--

Couvercle alvéolé qui améliore la condensation de la vapeur

Honeycomb lid increases steam condensation



Réserve d'eau permettant d'arroser la préparation sans soulever le couvercle
Water tank to allow watering food without lifting the lid



Fond induction plein
Full induction bottom



Accessoires en silicone amovibles
Removable silicone accessories



Idéal pour rôtir, mijoter et faire revenir viandes et poissons.
Ideal for roasting, simmering and browning meat and fish.



MATÉRIAU/MATERIAL

- Revêtement anti-adhérent renforcé / *Reinforced non-stick coating*
 - Fond indéformable 5 mm / *Non-warp 5-mm base*
- Revêtement extérieur en peinture siliconée ultra résistante à la chaleur
Exterior ultra heat-resistant silicone paint coating
 - Extérieur bicolore (rouge-gris), intérieur noir
Two tone exterior colorway: red and grey, black interior

ACCESSOIRES/ACCESSORIES

- Manche et poignée SoftTouch sans vis (●)
SoftTouch handle and grip without screw
- Double fond Full Induction pour plus de stabilité thermique (⊗)
Full induction double bottom for better thermal stability

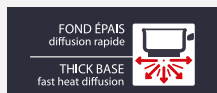



GRIL / GRIDDLE



REF.

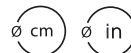

710790

24x24 / 9,46x9,46

6

PO LE / FRYING PAN



710791

20 / 7,88

1-2

6



710792

24 / 9,46

2-3

6



710793

28 / 11,03

3-4

4

CASSEROLE / SAUCEPAN



710788

16 / 6,30

1-2

6



710789

18 / 7,09

2-3

6

SAUTEUSE / SAUTE PAN



- avec couvercle vapeur verre
- with glass steam lid



710795

24 / 9,46

2-3

4

FAITOUT / DEEP STEWPOT



- avec couvercle vapeur verre
- with glass steam lid



710794

24 / 9,46

4-6

4

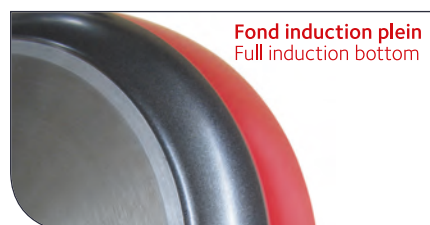

Fond induction plein
Full induction bottom



Idéal pour rôtir, mijoter et faire revenir viandes et poissons.
Ideal for roasting, simmering and browning meat and fish.

MATÉRIAU/MATERIAL

- Revêtement Premium 3 couches ultra résistant Teflon Select
Teflon Select Premium advanced reinforced 3-layer coating
 - Fond indéformable spécial induction 4,5 mm
Special 4.5-mm non-warp base for induction hobs
- Revêtement extérieur en peinture ultra résistante à la chaleur
High heat-resistant exterior paint coating

ACCESSOIRES/ACCESSORIES

- Manche et poignée thermorésistants / *Heat-resistant handle and grips*

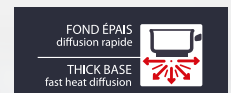

COCOTTE-GRIL / OVEN DISH

REF.

∅ cm ∅ in



3 108837 110026 **711002**

35x25 / 13,79x9,85 /



PLAT / SHALLOW DISH



3 108837 110019 **711001**

31x23 / 12,21x9,06 /



GAZ



GAS

ELECTRICITÉ



ELECTRICITY

RÉSISTANCE



COIL ELEMENT

VITROCERAM



HALOGEN

LAVE VAISSELLE



DISHWASHER Safe

NETTOYAGE FACILE



EASY TO CLEAN



- Manche et poignées thermorésistants
- Heat-resistant handle and grips

- Revêtement int. Teflon Select
- Teflon Select interior coating

PAPRIKA

FONTE D'ALUMINIUM / CAST ALUMINIUM

GRIL / GRIDDLE

REF.

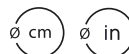

710626

24x24 / 9,46x9,46

/

6

CRÊPIÈRE / PANCAKE PAN



710625

26 / 10,24

/

6



710622

30 / 11,82

/

6

POËLE / FRYING PAN



710620

20 / 7,88

1-2

6



710621

24 / 9,46

2-3

6



710623

28 / 11,03

3-4

6



710624

32 / 12,61

4-5

4

SAUTEUSE / SAUTE PAN



- avec couvercle vapeur verre
- with glass steam lid



710628

28 / 11,03

4-6

4

WOK / WOK



- avec couvercle vapeur verre
- with glass steam lid



710627

28 / 11,03

4-6

4

FAITOUT / DEEP STEWPOT



- avec couvercle vapeur verre
- with glass steam lid



710629

24 / 9,46

4-6

4

GAZ 	ELECTRICITÉ 	INDUCTION 	RÉSISTANCE Spirale COIL ELEMENT 	VITROCERAM Halogène HALOGEN 	LAVE VAISSELLE DISHWASHER Safe 	NETTOYAGE FACILE EASY TO CLEAN
---------	-----------------	---------------	--	------------------------------------	---------------------------------------	---------------------------------------



Cette gamme répond à toutes les attentes et tendances : longévité, efficacité et style. Idéale pour mijoter, rôtir, saisir.
This range caters to all expectations and trends – durability, efficiency and style. Ideal for simmering, roasting and browning.

MATÉRIAU/MATERIAL

- Revêtement 3 couches premium breveté Select par Teflon® à la fois anti-abrasif, anti-rayure et sain (sans PFOA)
Premium patented Select 3-layer coating by Teflon® that is abrasion-, scratch-resistant and healthy (w/o PFOA)
- Matière indéformable / Non-warp material
- Fond spécial induction 4,5 mm / *Special 4.5mm base for induction hobs*
- Extérieur noir, intérieur couleur / *black exterior, colour interior*

ACCESSOIRES/ACCESSORIES

- Manche et poignées thermorésistant SoftTouch
SoftTouch heat-resistant handle and grips





















COLOUR COLLECTION



Intérieur disponible en 3 coloris (*Interior comes in 3 colourways*) : Champagne gold / Purple / Copper

CASSEROLE / SAUCEPAN



REF.	Ø cm	Ø in	Personnes	Boîte
  710762	16	6,30	1-2	4 
  710763	18	7,09	2-3	4 
  710778	16	6,30	1-2	4 
  710779	18	7,09	2-3	4 
  710770	16	6,30	1-2	4 
  710771	18	7,09	2-3	4 



GRIL / GRILL



REF.

∅ cm ∅ in



	3 108837 107613	710761	24x24 / 9,46x9,46	/	4	
	3 108837 107774	710777	24x24 / 9,46x9,46	/	4	
	3 108837 107699	710769	24x24 / 9,46x9,46	/	4	

POËLE / FRYPAN



	3 108837 107569	710756	24 / 9,46	1-2	4	
	3 108837 107576	710757	26 / 10,24	2-3	4	
	3 108837 107583	710758	28 / 11,03	3-4	4	
	3 108837 107729	710772	24 / 9,46	1-2	4	
	3 108837 107736	710773	26 / 10,24	2-3	4	
	3 108837 107743	710774	28 / 11,03	3-4	4	
	3 108837 107644	710764	24 / 9,46	1-2	4	
	3 108837 107651	710765	26 / 10,24	2-3	4	
	3 108837 107668	710766	28 / 11,03	3-4	4	

SAUTEUSE / SAUTE FRYPAN



• avec couvercle vapeur verre
• with glass steam lid

	3 108837 107606	710760	24 / 9,46	2-4	2	
	3 108837 107767	710776	24 / 9,46	2-4	2	
	3 108837 107682	710768	24 / 9,46	2-4	2	

FAITOUT / DEEP STEWPOT



• avec couvercle vapeur verre
• with glass steam lid

	3 108837 107590	710759	24 / 9,46	4-6	2	
	3 108837 107750	710775	24 / 9,46	4-6	2	
	3 108837 107675	710767	24 / 9,46	4-6	2	



Cette gamme répond à toutes les attentes et tendances : longévité, efficacité et style. Idéale pour mijoter, rôtir, saisir.

This range caters to all expectations and trends – durability, efficiency and style. Ideal for simmering, roasting and browning.

MATÉRIAU/MATERIAL

Revêtement 3 couches premium breveté Select par Teflon® à la fois anti-abrasif, anti-rayure et sain (sans PFOA)

Premium patented Select 3-layer coating by Teflon® that is abrasion-, scratch-resistant and healthy (w/o PFOA)

Matière indéformable / Non-warp material

Fond spécial induction 4,5 mm / *Special 4,5mm base for induction hobs*

Extérieur noir, intérieur couleur / *Black exterior, coloured interior*

ACCESSOIRES/ACCESSORIES

Manche et poignée thermorésistant SoftTouch

SoftTouch heat-resistant handle and grips



COLOUR COLLECTION

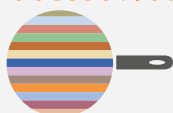

ECO RESPONSABLE
Fabriqué sans PFOA



Intérieur disponible en 4 coloris (*Interior comes in 4 colourways*) : Lavander blue / Champagne gold / Purple / Hot chilli

CASSEROLE / SAUCEPAN



REF. Ø cm Ø in

	710995	16 / 6,30	1-2	6
	710996	18 / 7,09	2-3	6
	710989	16 / 6,30	1-2	6
	710990	18 / 7,09	2-3	6
	710998	16 / 6,30	1-2	6
	710999	18 / 7,09	2-3	6
	710992	16 / 6,30	1-2	6
	710993	18 / 7,09	2-3	6

GAZ 	ELECTRICITÉ 	INDUCTION 	RÉSISTANCE Spirale COIL ELEMENT 	VITROCERAM Halogène HALOGEN 	LAVE VAISSELLE DISHWASHER Safe 	NETTOYAGE FACILE EASY TO CLEAN
---------	-----------------	---------------	--	------------------------------------	---------------------------------------	---------------------------------------

GRILL / GRIL



REF.

∅ cm ∅ in



	3 ¹ 108837 ¹ 109976	710997	24x24 / 9,46x9,46	/	6	
	3 ¹ 108837 ¹ 109914	710991	24x24 / 9,46x9,46	/	6	
	3 ¹ 108837 ¹ 110002	711000	24x24 / 9,46x9,46	/	6	
	3 ¹ 108837 ¹ 109945	710994	24x24 / 9,46x9,46	/	6	

POËLE / FRYPAN



	3 ¹ 108837 ¹ 109716	710971	20 / 7,88	1-2	6	
	3 ¹ 108837 ¹ 109723	710972	24 / 9,46	2-3	6	
	3 ¹ 108837 ¹ 109730	710973	26 / 10,24	2-3	6	
	3 ¹ 108837 ¹ 109747	710974	28 / 11,03	3-4	6	
	3 ¹ 108837 ¹ 109839	710983	20 / 7,88	1-2	6	
	3 ¹ 108837 ¹ 109846	710984	24 / 9,46	2-3	6	
	3 ¹ 108837 ¹ 109853	710985	26 / 10,24	2-3	6	
	3 ¹ 108837 ¹ 109860	710986	28 / 11,03	3-4	6	
	3 ¹ 108837 ¹ 109778	710977	20 / 7,88	1-2	6	
	3 ¹ 108837 ¹ 109785	710978	24 / 9,46	2-3	6	
	3 ¹ 108837 ¹ 109792	710979	26 / 10,24	2-3	6	
	3 ¹ 108837 ¹ 109808	710980	28 / 11,03	3-4	6	
	3 ¹ 108837 ¹ 109655	710965	20 / 7,88	1-2	6	
	3 ¹ 108837 ¹ 109662	710966	24 / 9,46	2-3	6	
	3 ¹ 108837 ¹ 109679	710967	26 / 10,24	2-3	6	
	3 ¹ 108837 ¹ 109686	710968	28 / 11,03	3-4	6	

SAUTEUSE / SAUTE FRYPAN



- avec couvercle vapeur verre
- with glass steam lid

	3 ¹ 108837 ¹ 109761	710976	24 / 9,46	2-4	4	
	3 ¹ 108837 ¹ 109884	710988	24 / 9,46	2-4	4	
	3 ¹ 108837 ¹ 109822	710982	24 / 9,46	2-4	4	
	3 ¹ 108837 ¹ 109709	710970	24 / 9,46	2-4	4	

FAITOUT / DEEP STEWPOT



- avec couvercle vapeur verre
- with glass steam lid

	3 ¹ 108837 ¹ 109754	710975	24 / 9,46	4-6	4	
	3 ¹ 108837 ¹ 109877	710987	24 / 9,46	4-6	4	
	3 ¹ 108837 ¹ 109815	710981	24 / 9,46	4-6	4	
	3 ¹ 108837 ¹ 109693	710969	24 / 9,46	4-6	4	



Cette gamme répond à toutes les attentes et tendances : longévité, efficacité et style. Idéale pour mijoter, rôtir, saisir.
This range caters to all expectations and trends – durability, efficiency and style. Ideal for simmering, roasting and browning.

MATÉRIAU/MATERIAL

- Revêtement 3 couches premium breveté Select par Teflon® à la fois anti-abrasif, anti-rayure et sain (sans PFOA)
Premium patented Select 3-layer coating by Teflon® that is abrasion-, scratch-resistant and healthy (w/o PFOA)
 - Matière indéformable / Non-warp material
- Fond spécial induction 4,5 mm / *Special 4,5mm base for induction hobs*
- Intérieur et extérieur couleur / *Coloured interior and exterior*

ACCESSOIRES/ACCESSORIES

- Manche et poignée thermorésistant SoftTouch
SoftTouch heat-resistant handle and grips



Poêles disponibles en 2 coloris (*Frying pans come in 2 colourways*) : Lavander blue / Champagne gold



GAZ
GAS



ELECTRICITÉ
ELECTRICITY



INDUCTION
INDUCTION



RÉSISTANCE
Spirale
COIL
ELEMENT



VITROCERAM
Halogène
HALOGEN



LAVE
VAISSELLE
DISHWASHER
Safe



NETTOYAGE
FACILE
EASY
TO CLEAN



CASSEROLE / SAUCEPAN



REF.



3¹108837¹109624

710962

16 / 6,30

1-2

6



3¹108837¹109631

710963

18 / 7,09

2-3

6



3¹108837¹109648

710964

20 / 7,88

3-4

6



POÊLE / FRYING PAN



3¹108837¹109525

710952

20 / 7,88

1-2

6



3¹108837¹109532

710953

24 / 9,46

2-3

6



3¹108837¹109594

710959

26 / 10,24

2-3

6



3¹108837¹109549

710954

28 / 11,03

3-4

6



3¹108837¹109556

710955

20 / 7,88

1-2

6



3¹108837¹109563

710956

24 / 9,46

2-3

6



3¹108837¹109570

710957

28 / 11,03

3-4

6



LOT 2 POÊLES / 2 FRYPAN SET



3¹108837¹109587

710958

24-28 / 9,46-11,03

2-4

4



SAUTEUSE / SAUTE FRYPAN



- avec couvercle vapeur verre
- with glass steam lid



3¹108837¹109600

710960

24 / 9,46

2-4

4



FAITOUT / DEEP STEWPOT



- avec couvercle vapeur verre
- with glass steam lid



3¹108837¹109617

710961

24 / 9,46

4-6

4



GAZ



ELECTRICITÉ



INDUCTION



RÉSISTANCE Spirale



VITROCERAM Halogène



LAVE VAISSELLE



NETTOYAGE FACILE





**Une gamme ultra résistante avec le revêtement le plus performant.
Une durabilité supérieure pour une utilisation intensive.**
*An ultra-resistant range with the highest performing coating.
Harder-wearing for intensive use.*

MATÉRIAU/MATERIAL

- Corps en aluminium 4,8 mm / *Body in aluminium 4.8mm*
- Revêtement anti-adhérent Teflon Radiance 3 couches : dure jusqu'à 2 fois plus longtemps.
3-layer Teflon Radiance non-stick coating: lasts up to twice as long
- Revêtement sans PFOA pour une cuisson plus saine
PFOA-free coating for healthier cooking
- Fond full induction épaisseur professionnelle 5,3 mm
Full 5.3mm professional gauge induction bottom

ACCESSOIRES/ACCESSORIES

- Manche et poignées thermorésistants / *Heat-resistant handle and grips*



CASSEROLE / SAUCEPAN



REF.



710344

16 / 6,30

1,3 / 1,37

1-2

4



710345

18 / 7,09

1,9 / 2,01

2-3

4



710346

20 / 7,88

2,5 / 2,64

3-4

4

GRILL / GRIDDLE



710353

28 / 11,03

4



- Revêtement anti-adhérent
- Non-stick coating

- Manche et poignées thermorésistants
- Heat-resistant handle & grips



ALUMINIUM FORGÉ / FORGED LUMINIUM

CRÊPIÈRE / PANCAKE PAN

REF.

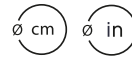

710357

28 / 11,03

4

POËLE / FRYING PAN



710347

20 / 7,88

1,1 / 1,16

1-2

4



710348

24 / 9,46

1,8 / 1,90

2-3

4



710349

26 / 10,24

2 / 2,11

2-3

4



710350

28 / 11,03

2,9 / 3,06

3-4

4



710351

30 / 11,82

3 / 3,17

4-5

4



710352

32 / 12,61

3,7 / 3,91

5-6

4

WOK / WOK



710356

30 / 11,82

4 / 4,23

5-7

4

SAUTEUSE / SAUTE PAN



- avec couvercle vapeur verre
- with glass steam lid



710355

28 / 11,03

4-6

4

FAITOUT / DEEP STEWPOT



- avec couvercle vapeur verre
- with glass steam lid



710354

24 / 9,46

3,6 / 3,80

4-6

2



Fond full induction
Full induction bottom

GAZ 	ELECTRICITÉ ELECTRICITY 	INDUCTION 	RÉSISTANCE Spirale COIL ELEMENT 	VITROCERAM Halogène HALOGEN 	LAVE VAISSELLE DISHWASHER Safe 	NETTOYAGE FACILE EASY TO CLEAN
---------	--------------------------------	---------------	--	------------------------------------	---------------------------------------	---------------------------------------

L'aluminium forgé est un alliage léger qui permet une répartition rapide et homogène de la chaleur.

Forged aluminium is a light alloy that diffuses the heat quickly and evenly.



MATÉRIAU/MATERIAL

- Revêtement anti-adhérent haute qualité, haute résistance
High-quality, high-strength non-stick coating
- Fond spécial induction 4 mm / *Special 4mm base for induction hobs*

ACCESSOIRES/ACCESSORIES

- Manche et poignée SoftTouch thermorésistant
SoftTouch heat-resistant handle and grips



GAZ



GAS

ELECTRICITÉ



ELECTRICITY

INDUCTION



INDUCTION

RÉSISTANCE



COIL ELEMENT

VITROCERAM



HALOGEN

NETTOYAGE FACILE



EASY TO CLEAN

- Revêtement anti-adhérent
- *Non-stick coating*

- Manche, poignée thermorésistants
- *Heat-resistant handle and grips*



CASSEROLE / SAUCEPAN

REF.

∅ cm ∅ in



710713

16 / 6,30

1-2

4



710714

18 / 7,09

2-3

4



710715

20 / 7,88

3-4

4

POÊLE / FRYING PAN



710708

20 / 7,88

1-2

6



710709

24 / 9,46

2-3

6



710710

28 / 11,03

3-4

6

WOK / WOK



710711

28 / 11,03

4-6

6

SAUTEUSE / SAUTE PAN



- avec couvercle vapeur verre
- *with glass steam lid*



710712

28 / 11,03

4-6

4

FAITOUT / DEEP STEWPOT



- avec couvercle vapeur verre
- *with glass steam lid*



710716

24 / 9,46

4-6

4

GAZ GAS		ELECTRICITÉ ELECTRICITY		INDUCTION		RÉSISTANCE Spirale COIL ELEMENT		VITROCÉRAM Halogène HALOGEN		NETTOYAGE FACILE EASY TO CLEAN	
------------	--	----------------------------	--	-----------	--	------------------------------------	--	--------------------------------	--	-----------------------------------	--

Pour une cuisson rapide, avec une diffusion homogène de la chaleur.
Un design moderne, aux couleurs tendance.

For fast cooking and even heat diffusion. A modern design in trendy colors.



MATÉRIAU/MATERIAL

- Revêtement à base de céramique noir ILAG sans PFOA pour une cuisine saine
ILAG black ceramic PFOA-free coating for healthy cooking
- Fond spécial induction / *Special base for induction hobs*

ACCESSOIRES/ACCESSORIES

- Manche et poignée inox rivetés pour une meilleure sécurité
Extra-safe riveted handle and grips



GAZ



ELECTRICITÉ



INDUCTION



RÉSISTANCE

Spirale



VITROCERAM

Halogène



LAVE

VAISSELLE



NETTOYAGE

FACILE



- Revêtement à base de céramique ILAG
- ILAG ceramic coating



CASSEROLE / SAUCEPAN

REF.

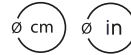

710704

16 / 6,30

1-2

4



710705

18 / 7,09

2-3

4



710706

20 / 7,88

3-4

4



POÊLE / FRYING PAN



710699

20 / 7,88

1-2

6



710700

24 / 9,46

2-3

6



710701

28 / 11,03

3-4

6



WOK / WOK



710702

28 / 11,03

4-6

6



SAUTEUSE / SAUTE PAN



- avec couvercle vapeur verre
- with glass steam lid



710703

28 / 11,03

4-6

4



FAITOUT / DEEP STEWPOT



- avec couvercle vapeur verre
- with glass steam lid



710707

24 / 9,46

4,5 / 4,75

4-6

4



Pour une cuisson rapide, avec une diffusion homogène de la chaleur.
Un design moderne, aux couleurs tendance.

For fast cooking and even heat diffusion. A modern design in trendy colors.



MATÉRIAU/MATERIAL

- Revêtement à base de céramique blanc ILAG sans PFOA pour une cuisine saine
ILAG white ceramic PFOA-free coating for healthy cooking
- Fond spécial induction / *Special base for induction hobs*

ACCESSOIRES/ACCESSORIES

- Manche et poignée inox rivetés pour une meilleure sécurité
Extra-safe riveted handle and grips



FAITOUT / DEEP STEWPOT

REF.



- avec couvercle vapeur verre
- with glass steam lid



710698

24 / 9,46

4,5 / 4,75

4-6

4



GAZ



ELECTRICITÉ



INDUCTION



RÉSISTANCE Spirale



VITROCERAM Halogène



LAVE VAISSELLE



NETTOYAGE FACILE





CASSEROLE / SAUCEPAN

REF.

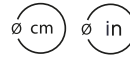

3 ¹ 108837 ¹ 106951	710695	16 / 6,30	1-2	4	
3 ¹ 108837 ¹ 106968	710696	18 / 7,09	2-3	4	
3 ¹ 108837 ¹ 106975	710697	20 / 7,88	3-4	4	

POÊLE / FRYING PAN



3 ¹ 108837 ¹ 106906	710690	20 / 7,88	1-2	6	
3 ¹ 108837 ¹ 106913	710691	24 / 9,46	2-3	6	
3 ¹ 108837 ¹ 106920	710692	28 / 11,03	3-4	6	

WOK / WOK



3 ¹ 108837 ¹ 106937	710693	28 / 11,03	4-6	6	
---	---------------	------------	-----	---	--

CRÊPIÈRE / PANCAKE PAN



3 ¹ 108837 ¹ 108061	710806	25 / 9,85		6	
---	---------------	-----------	--	---	--

SAUTEUSE / SAUTE PAN



- avec couvercle vapeur verre
- with glass steam lid

3 ¹ 108837 ¹ 106944	710694	28 / 11,03	4-6	4	
---	---------------	------------	-----	---	--

GAZ GAS		ELECTRICITÉ ELECTRICITY		INDUCTION		RÉSISTANCE Spirale COIL ELEMENT		VITROCERAM Halogène HALOGEN		LAVE VAISSELLE DISHWASHER Safe		NETTOYAGE FACILE EASY TO CLEAN	
------------	--	----------------------------	--	-----------	--	------------------------------------	--	--------------------------------	--	-----------------------------------	--	-----------------------------------	--

Pour une cuisson rapide, avec une diffusion homogène de la chaleur.
Un design moderne, aux couleurs tendance.

For fast cooking and even heat diffusion. A modern design in trendy colors.



MATÉRIAU/MATERIAL

- Revêtement à base de céramique blanc ILAG sans PFOA pour une cuisine saine
ILAG white ceramic PFOA-free coating for healthy cooking
- Fond spécial induction / *Special base for induction hobs*

ACCESSOIRES/ACCESSORIES

- Manche et poignée inox rivetés pour une meilleure sécurité
Extra-safe riveted handle and grips



FAITOUT / DEEP STEWPOT

REF.

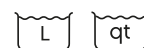
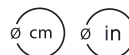

- avec couvercle vapeur verre
- with glass steam lid



710837

24 / 9,46

4,5 / 4,75

4-6

4





CASSEROLE / SAUCEPAN

REF.

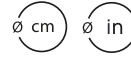

710834

16 / 6,30

1-2

4



710835

18 / 7,09

2-3

4



710836

20 / 7,88

3-4

4



POÊLE / FRYING PAN



710829

20 / 7,88

1-2

6



710830

24 / 9,46

2-3

6



710831

28 / 11,03

3-4

6



WOK / WOK



710832

28 / 11,03

4-6

6



CRÊPIÈRE / PANCAKE PAN



710838

25 / 9,85

6



SAUTEUSE / SAUTE PAN



- avec couvercle vapeur verre
- with glass steam lid



710833

28 / 11,03

4-6

4



Pour votre cuisine au quotidien.
For everyday cooking.

MATÉRIAU/MATERIAL

- Revêtement intérieur anti-adhérent / *Interior non-stick coating*
- Fond spécial induction / *Special base for induction hobs*

ACCESSOIRES/ACCESSORIES

- Poignée-pince amovible thermorésistante
Removable heat-resistant clamp-on handle



POIGNÉE-PINCE AMOVIBLE POUR GAMME SITRAMULTI / REMOVABLE CLAMP-ON HANDLE FOR SITRAMULTI RANGE



710824



GAZ GAS		ELECTRICITÉ ELECTRICITY		INDUCTION		RÉSISTANCE Spirale COIL ELEMENT		VITROCERAM Halogène HALOGEN		LAVE VAISSELLE DISHWASHER Safe		NETTOYAGE FACILE EASY TO CLEAN	
------------	--	----------------------------	--	-----------	--	--	--	-----------------------------------	--	---	--	---	--

REF.

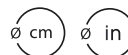

LOT DE 3 CASSEROLES + poignée-pince amovible / 3-PIECE SAUCEPAN SET + removable clamp-on handle



	3 108830 522253	710877	16-18-20 / 6,30-7,09-7,88	1-4	6	
	3 108830 533549	710876	16-18-20 / 6,30-7,09-7,88	1-4	6	

LOT DE 3 POÊLES + poignée-pince amovible / 3-PIECE FRYPAN SET + removable clamp-on handle



	3 108830 523847	710875	20-24-28 / 7,88-9,46-11,03	1-4	6	
	3 108830 533532	710878	20-24-28 / 7,88-9,46-11,03	1-4	6	

SAUTEUSE + poignée-pince amovible / SAUTÉ PAN + removable clamp-on handle



- avec couvercle vapeur en verre
- with glass steam lid

	3 108830 523854	710880	28 / 11,03	1-4	6	
	3 108830 533556	710879	28 / 11,03	1-4	6	

WOK + poignée-pince amovible / WOK + removable clamp-on handle



	3 108830 533570	710882	28 / 11,03	4-6	6	
	3 108830 533563	710881	28 / 11,03	4-6	6	

GAZ 	ELECTRICITÉ 	INDUCTION 	RÉSISTANCE Spirale COIL ELEMENT 	VITROCERAM Halogène HALOGEN 	LAVE VAISSELLE DISHWASHER Safe 	NETTOYAGE FACILE EASY TO CLEAN
---------	-----------------	---------------	--	------------------------------------	---------------------------------------	---------------------------------------



Une collection idéale pour savourer des moments en famille ou entre amis.

This collection is ideal for enjoying precious moments with family and friends.

MATÉRIAU/MATERIAL

- Corps en aluminium 2,5 mm / 2.5mm aluminium body
- Revêtement antiadhérent sans PFOA / Non-stick coating PFOA free

ACCESSOIRES/ACCESSORIES

- Fond induction / Special base for induction hobs
- Poignée thermorésistante SoftTouch / SoftTouch heat-resistant handle
- Couvercle en verre trempé avec bouton thermorésistant SoftTouch
Tempered glass lid with heat-resistant SoftTouch knob



GAZ



GAZ

ELECTRICITÉ



ELECTRICITY

INDUCTION



INDUCTION

RÉSISTANCE

Spirale



COIL
ELEMENT

VITROCERAM

Halogène

HALOGEN



LAVE

VAISSELLE

DISHWASHER
Safe



NETTOYAGE

FACILE

EASY
TO CLEAN



CASSEROLE / SAUCEPAN

REF.



- Poignée thermorésistante SoftTouch
- SoftTouch heat-resistant handle



710296

16 / 6,30

1,5 / 1,58

1-2

6



710297

18 / 7,09

1,8 / 1,90

2-3

6



710298

20 / 7,88

2,5 / 2,64

3-4

6

LOT DE 3 CASSEROLES / SAUCEPAN X3



- Poignée thermorésistante SoftTouch
- SoftTouch heat-resistant handle



710303

16-18-20
6,30-7,09-7,881,5-1,8-2,5
1,58-1,90-2,64

1-4

4

POÊLE / FRYING PAN



- Poignée thermorésistante SoftTouch
- SoftTouch heat-resistant handle



710299

20 / 7,88

1,3 / 1,37

1-2

6



710300

24 / 9,46

2,3 / 2,43

2-3

6



710301

28 / 11,03

3,4 / 3,59

3-4

6

WOK / WOK



- Couvercle vapeur en verre
- Glass steam lid

- Poignée thermorésistante SoftTouch
- SoftTouch heat-resistant handle & knob



710507

30 / 11,82

/

5-7

4



FAITOUT / DEEP STEWPOT



- Couvercle vapeur en verre
- Glass steam lid

- Poignée thermorésistante SoftTouch
- SoftTouch heat-resistant handle & knob



710302

24 / 9,46

4,9 / 5,18

4-6

4



GAZ



ELECTRICITÉ



INDUCTION

RÉSISTANCE
SpiraleVITROCERAM
HalogèneLAVE
VAISSELLENETTOYAGE
FACILE

Grâce à son revêtement d'exception, composé de particules de titane, notre gamme assure une résistance incomparable et durable. Les aliments n'attachent pas, le lavage devient extrêmement facile.

With its exceptional coating composed of titanium particles, our range offers unmatched, long-lasting wear. Food does not adhere, while washing is really easy.



TITANE

MATÉRIAU/MATERIAL

- Aluminium 3 mm pressé / *Pressed 3-mm aluminium*
- Peinture extérieure hautement résistante à la chaleur
High heat-resistant exterior paint coating
- Fond 5 mm spécial induction / *Special 5-mm base for induction hobs*
- Revêtement ultra résistant renforcé en titane (résiste aux ustensiles métalliques)
High wear-resistant titanium-filled coating (withstands metal utensils)

ACCESSOIRES/ACCESSORIES

- Manche thermorésistant / *Heat-resistant handle*



GAZ



GAZ

ELECTRICITÉ



ELECTRICITY

INDUCTION



INDUCTION

RÉSISTANCE

Spirale

COIL

ELEMENT



VITROCERAM

Halogène

HALOGEN



LAVE

VAISSELLE

DISHWASHER

Safe



NETTOYAGE

FACILE

EASY

TO CLEAN



TITANE

**GARANTIE
10 ANS
REVÊTEMENT**

- Revêtement ultra résistant renforcé en titane
- Highly resistant titanium coating

- Manche thermorésistant
- Heat-resistant handle



POÊLE / FRYING PAN

REF.

∅ cm

∅ in



710782

20 / 7,88

1-2

6



710783

24 / 9,46

2-3

6



710784

28 / 11,03

3-4

6



710785

30 / 11,82

4-5

6



GAZ



ELECTRICITÉ

ELECTRICITY



INDUCTION

INDUCTION



RÉSISTANCE

COIL ELEMENT



VITROCERAM

HALOGEN



LAVE

DISHWASHER

Safe



NETTOYAGE

EASY TO CLEAN



Cette gamme vous permettra de sauter et rissoler sans risque de projections.
This range is for splatter-free sautéing and browning.



MATÉRIAU/MATERIAL

- Aluminium 2,5 mm pressé / *2.5-mm pressed aluminum*
 - Revêtement intérieur anti-adhérent PTFE 2 couches
2-layer PTFE interior non-stick coating
 - Peinture extérieure hautement résistante à la chaleur
Exterior paint with ultra heat resistance
- Fond spécial induction / *Special base for induction hobs*

ACCESSOIRES/ACCESSORIES

- Manche thermorésistant SoftTouch / *SoftTouch heat-resistant handle*



SPECIAL BORD HAUT

La profondeur idéale pour faire sauter et rissoler

SPECIAL HIGH EDGE

The ideal depth for sautéing and browning



- Revêtement anti-adhérent
- *Non-stick coating*

- Manche thermorésistant SoftTouch
- *Heat-resistant handle*



POÊLE / FRYING PAN

REF.

∅ cm ∅ in



710741

20 / 7,88

1-2

6



710742

24 / 9,46

2-3

6



710743

28 / 11,03

3-4

6



710744

32 / 12,61

4-5

6

SPECIAL BORD HAUT
La profondeur idéale pour faire sauter et rissoler

SPECIAL HIGH EDGE
The ideal depth for sautéing and browning



Pour votre cuisine au quotidien.
For your daily kitchen needs.

MATÉRIAU/MATERIAL

- Disque d'aluminium 3,5 mm pressé
Pressed aluminium disc 3.5mm
- Revêtement intérieur anti-adhérent PTFE 2 couches
2-layer PTFE non-stick interior coating
- Revêtement extérieur résistant à la chaleur
Heat-resistant exterior coating
- Fond spécial induction / *Special base for induction hobs*

ACCESSOIRES/ACCESSORIES

- Manche thermorésistant / *Heat-resistant stick handle*



GAZ



GAZ

ELECTRICITÉ



ELECTRICITY

INDUCTION



INDUCTION

RÉSISTANCE

Spirale



COIL
ELEMENT

VITROCERAM

Halogène

HALOGEN



LAVE

VAISSELLE

DISHWASHER
Safe



NETTOYAGE

FACILE

EASY
TO CLEAN





POÊLE / FRYING PAN

REF.

∅ cm ∅ in



710631

20 / 7,88

1-2

12



710632

24 / 9,46

2-3

12



710633

28 / 11,03

3-4

12



710634

32 / 12,61

4-5

12

CRÊPIÈRE / PANCAKE PAN



710630

28 / 11,03

/

12



GAZ 	ELECTRICITÉ ELECTRICITY	INDUCTION INDUCTION	RÉSISTANCE Spirale COIL ELEMENT	VITROCERAM Halogène HALOGEN	LAVE VAISSELLE DISHWASHER Safe	NETTOYAGE FACILE EASY TO CLEAN
---------	----------------------------	------------------------	--	-----------------------------------	---	---



French Durable Professional

SITRAM

SITRABELLA

FONTE D'ACIER ÉMAILLÉE - ENAMELED CAST IRON



TOUS FEUX DONT INDUCTION
ALL HOB INCLUDING INDUCTION



Une gamme de cocottes rondes et ovales, alliant modernité et fonctionnalité grâce à l'ergonomie des poignées.

Round and oval range of casseroles combining modernity and functionality thanks to ergonomic handles.

MATÉRIAU / MATERIAL

Fonte d'acier haute qualité, haute résistance
Cast iron high quality and strength

REVÊTEMENT / COATING

Émaillé extérieur et intérieur
Enamelled outside and inside

ACCESSOIRES / FITMENTS

Poignées fonte d'acier
Cast iron handles
Bouchon inox
Stainless steel knob



FOUR
OVEN SAFE



FOND ÉPAIS
diffusion rapide
THICK BASE
fast heat diffusion



SITRABELLA

FONTE D'ACIER ÉMAILLÉE - ENAMELED CAST IRON



COCOTTE RONDE

REF.



Extérieur rouge - Intérieur noir / Red outside - Black inside



711089

20

7,88

2,5

2,64

2-3

2



711090

25

9,85

5

5,28

5-7

2



Extérieur noir - Intérieur noir / Black outside - Black inside



711093

20

7,88

2,5

2,64

2-3

2



711094

25

9,85

5

5,28

5-7

2



COCOTTE OVALE

Extérieur rouge - Intérieur noir / Red outside - Black inside



711087

26x21 / 10,24x8,27

4

4,23

4-6

2



711088

31x24 / 12,21x9,46

6,5

6,87

6-8

2



Extérieur noir - Intérieur noir / Black outside - Black inside



711091

26x21 / 10,24x8,27

4

4,23

4-6

2



711092

31x24 / 12,21x9,46

6,5

6,87

6-8

2



ARROSAGE CONTINU
DES ALIMENTS
DURANT LA CUISSON
AUTOMATIC
STEAMING COOK

Une gamme complète de cocottes rondes et ovales, alliant tradition et modernité, idéale pour rôtir et mijoter.

A full range of round and oval ovenware that draws from tradition and modern styles and is ideal for roasting and simmering.

MATÉRIAU/MATERIAL

- Fonte d'acier haute qualité, haute résistance
High-quality, high-strength cast steel
- Fonte d'acier émaillé extérieur et intérieur
Enamelled cast iron exterior and interior

ACCESSOIRES/ACCESSORIES

- Poignées fonte d'acier / *Cast iron handles*
- Bouchon inox / *Stainless steel knob*



GRILL / GRIL

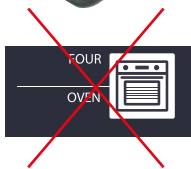

REF.



Extérieur noir - Intérieur noir - Manche bois / *Black exterior - Black interior - Wooden handle*



710745

24x24 / 9,46x9,46

/

/

6



710746

21x35 / 8,27x13,79

/

/

6



710747

23 / 9,06

/

/

6



GAZ



GAZ

ELECTRICITÉ



ELECTRICITY

INDUCTION



INDUCTION

RÉSISTANCE



COIL ELEMENT

VITROCERAM



HALOGENE

NETTOYAGE



EASY TO CLEAN

COCOTTE RONDE / ROUND OVEN POT

REF.

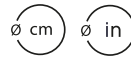

Extérieur rouge flamme - Intérieur blanc / *Flame red exterior - White interior*

3 108837 108429	710842	21 / 8,27	2,5 / 2,64	1-2	2	
3 108837 108436	710843	24 / 9,46	4 / 4,23	3-4	2	
3 108837 108443	710844	26 / 10,24	5 / 5,28	5-6	2	
3 108837 110583	711058	32 / 12,61	9 / 9,51	7-8	2	



Extérieur rouge flamme - Intérieur noir / *Flame red exterior - Black interior*

3 108837 110675	711067	21 / 8,27	2,5 / 2,64	1-2	2	
3 108837 110682	711068	24 / 9,46	4 / 4,23	3-4	2	
3 108837 110699	711069	26 / 10,24	5 / 5,28	5-6	2	
3 108837 110705	711070	32 / 12,61	9 / 9,51	7-8	2	



Extérieur noir - Intérieur noir / *Black exterior and interior*

3 108837 110743	711074	21 / 8,27	2,5 / 2,64	1-2	2	
3 108837 110750	711075	24 / 9,46	4 / 4,23	3-4	2	
3 108837 110767	711076	26 / 10,24	5 / 5,28	5-6	2	
3 108837 110774	711077	32 / 12,61	9 / 9,51	7-8	2	

COCOTTE OVALE / OVAL OVEN POT



Extérieur rouge flamme - Intérieur blanc / *Flame red exterior - White interior*

3 108837 108399	710839	27x21 / 10,64x8,27	4 / 4,23	3-4	2	
3 108837 108405	710840	33x25 / 13x9,85	6,5 / 6,87	5-6	2	
3 108837 108412	710841	36x28 / 14,18x11,03	9 / 9,51	7-8	2	



Extérieur rouge flamme - Intérieur noir / *Flame red exterior - Black interior*

3 108837 110644	711064	27x21 / 10,64x8,27	4 / 4,23	3-4	2	
3 108837 110651	711065	33x25 / 13x9,85	6,5 / 6,87	5-6	2	
3 108837 110668	711066	36x28 / 14,18x11,03	9 / 9,51	7-8	2	



Extérieur noir - Intérieur noir / *Black exterior and interior*

3 108837 110712	711071	27x21 / 10,64x8,27	4 / 4,23	3-4	2	
3 108837 110729	711072	33x25 / 13x9,85	6,5 / 6,87	5-6	2	
3 108837 110736	711073	36x28 / 14,18x11,03	9 / 9,51	7-8	2	



La rencontre de la tradition et du design.
Des conditions idéales réunies pour cuire, mijoter et réchauffer.
*Tradition and design meet, bringing together the ideal conditions
for cooking, simmering and heating*



MATÉRIAU/MATERIAL

- Fonte d'acier fine pour une excellente répartition et restitution de la chaleur
Fine cast steel for excellent heat diffusion and release
 - Revêtement anti-adhérent / *Non-stick coating*

ACCESSOIRES/ACCESSORIES

- Manche et poignées inox rivetés pour une meilleure sécurité
Extra-safe stainless steel riveted handle and grips



- Revêtement anti-adhérent

- Non-stick coating

- Manche et poignées inox

- Stainless steel handle and grips

POÊLE / FRYING PAN

REF.

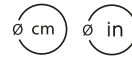

710717

20 / 7,88

1-2

6



710718

24 / 9,46

2-3

6



710719

28 / 11,03

3-4

6



WOK / WOK



710720

30 / 11,82

5-7

6



FAITOUT / STEWPOT



- avec couvercle vapeur verre
- with glass steam lid



710721

24 / 9,46

3,5 / 3,70

4-6

4



710722

28 / 11,03

6 / 6,34

6-8

4



FAITOUT BAS / SHALLOW STEWPOT



- avec couvercle vapeur verre
- with glass steam lid



710723

26 / 10,24

3 / 3,17

4-6

4



GAZ



ELECTRICITÉ



INDUCTION



RÉSISTANCE

Spirale
COIL
ELEMENT



VITROCERAM

Halogène
HALOGEN



LAVE

VAISSELLE
DISHWASHER
Safe



NETTOYAGE

FACILE
EASY
TO CLEAN



Une série de casseroles traditionnelles pour votre cuisine au quotidien.
La résistance mécanique de l'acier s'allie à l'inaltérabilité et à l'éclat de l'émail.

*A set of traditional saucepans for everyday cooking that combines
the strength of the steel with wear-free, bright enamel.*

MATÉRIAU/MATERIAL

- Intérieur et extérieur émaillé
Enamelled interior and exterior

ACCESSOIRES/ACCESSORIES

- Manche thermorésistant
Heat-resistant handle



SÉRIE DE 5 CASSEROLES / 5-PIECE SAUCEPAN SET

REF.



710331

12-14-16 / 4,73-5,52-6,30
18-20 / 7,09-7,88

1-4

4



• Intérieur et extérieur émaillé
• *Enamelled interior and exterior*

• Manche thermorésistant
• *Heat-resistant handle*

GAZ



ELECTRICITÉ

ELECTRICITY



INDUCTION

INDUCTION



RÉSISTANCE
Spirale

COIL
ELEMENT



VITROCERAM
Halogène

HALOGEN



LAVE
VAISSELLE

DISHWASHER
Safe



NETTOYAGE
FACILE

EASY
TO CLEAN



SITRAM

CHICKEN COOK

ACIER ÉMAILLÉ - ENAMELED STEEL



Une gamme traditionnelle pour votre cuisine au quotidien. La résistance mécanique de l'acier s'allie à l'inaltérabilité et à l'éclat de l'émail.

An authentic range, to cook everyday. The strength of the steel with wear-free, bright enamel.

REVÊTEMENT / COATING

Emailé extérieur et intérieur

Enamelled outside and inside

ACCESSOIRES / FITMENTS

Manche thermo-résistant

Thermo-resistant handle

Couvercle avec poignée thermo-résistante

Lid with heat-resistant handle

TOUS FEUX DONT INDUCTION

ALL HOB INCLUDING INDUCTION



MANCHE
thermo-résistant
ERGONOMIQUE
Thermo-resistant
HANDLE
ERGONOMIC



SITRAM

CHICKEN COOK

ACIER ÉMAILLÉ - ENAMELED STEEL

CASSEROLE / SAUCEPAN

REF.



711095

12 4,73

1 5



711096

14 5,52

1 5



711097

18 7,09

2-3 5



711098

20 7,88

3-4 5

FAITOUT / DEEP STEWPOT



711100

24 9,46 4,5 4,75 4-6 4

SAUTEUSE / SAUTE PAN



711101

24 9,46

2-4 4



Cette gamme en acier diffusera très rapidement la chaleur pour une cuisson rapide, idéale pour vos repas au quotidien.
This steel range diffuses heat very quickly for rapid cooking, making it ideal for your daily meals.

MATÉRIAU/MATERIAL

Corps en acier 1,2 mm / 1.2-mm steel body
 Revêtement anti-adhérent Teflon Classic 2 couches sans PFOA
 2-layer Teflon Classic PFOA free non-stick coating
 Fond special induction / Special base for induction hobs

ACCESSOIRES/ACCESSORIES

Manche et poignée thermorésistant avec insert inox
 Heat-resistant handles with stainless steel insert



CASSEROLE / SAUCEPAN

REF.

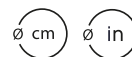

3¹108831 052780 **710093**

12 / 4,73

0,5 / 0,53

1

5



3¹108831 052797 **710094**

14 / 5,52

1 / 1,06

1

5



3¹108831 052803 **710095**

16 / 6,30

1,5 / 1,58

1-2

5



3¹108831 052810 **710096**

18 / 7,09

2,3 / 2,43

2-3

5



3¹108831 052827 **710097**

20 / 7,88

3,1 / 3,28

3-4

5



SÉRIE DE 4 CASSEROLE / 4-PIECE SAUCEPAN SET

3¹108830 525346 **710332**

14 / 5,52 - 16 / 6,30

18 / 7,09 - 20 / 7,88

1-4

4



GAZ



ELECTRICITÉ



INDUCTION



RÉSISTANCE Spirale



VITROCERAM Halogène



LAVE VAISSELLE



NETTOYAGE FACILE





- Revêtement anti-adhérent
- Non-stick coating

- Manche et poignées thermorésistant
- Heat-resistant handles

ECO RESPONSABLE
Fabriqué sans PFOA

CRÊPIÈRE / PANCAKE PAN

REF.

∅ cm ∅ in

L

qt



710108

25 / 9,85

9



POÊLE / FRYING PAN



710098

20 / 7,88

1-2

6



710099

24 / 9,46

2-3

6



710100

26 / 10,24

2-3

6



710101

28 / 11,03

3-4

6



SAUTEUSE / SAUTE PAN



710103

24 / 9,46

2-4

4



- avec couvercle inox
- with stainless steel lid

FAITOUT / DEEP STEWPOT



710102

24 / 9,46

4-6

4



- avec couvercle inox
- with stainless steel lid

GAZ



ELECTRICITÉ



INDUCTION



RÉSISTANCE

Spirale
COIL
ELEMENT



VITROCERAM

Halogène
HALOGEN



LAVE

VAISSELLE
DISHWASHER
Safe



NETTOYAGE

FACILE
EASY
TO CLEAN





French Durable Professional

SITRAM PIÈCES DÉTACHÉES POUR AUTOCUISEUR

PRESSURE COOKER SPARES

POIGNÉE COUVERCLE / LID HANDLE

REF.



GAMME/RANGE



710606

710606

SitraForza

10



710945

SitraMondo

10

ANSE CUVE / BODY GRIP



710107



710072

710107

SitraSpeedo

10



710072

SitraForza

10



710220

SitraMondo

10



710220

INDICATEUR PRESSION / EXPRESS INDICATOR



710141

SitraSpeedo
SitraShark
SitraExpress

200



PANIER / BASKET

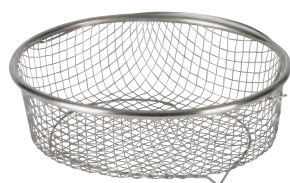

710892

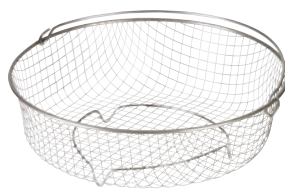

710586

710892

SitraForza

10



710586

SitraForza

10













SITRAM PIÈCES DÉTACHÉES POUR AUTOCUISEUR

PRESSURE COOKER SPARES







JOINT / GASKET



REF.	∅ cm	∅ in	GAMME/RANGE		
 710073	24	9,46	Forza / Version Originale Forza+ / Mondo / Prima Squadra / Siena / Primo 4/6/8/10/13L Ø 24cm	10	
 710602	22	8,67	Pallas / Vulcain / Miss Inox 5L Ø 22cm	10	
 710603	24	9,46	Pallas / Vulcain / Miss Inox 8L Ø 24cm	10	
 710604	28	11,03	Pallas / Vulcain / Miss Inox 10/18L Ø 28cm	10	
 710110	28	11,03	Speedo 4/6/8/10/13L Ø 24cm	10	

RÉGULATEUR / REGULATOR











 710074	Forza / Forza+ / Mondo Version Originale	10	
 710950	SitraMondo	1	
 710111	SitraSpeedo	200	

COUVERCLE COMPLET / COMPLETE LID

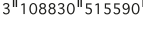

710600

 710600	SitraSpeedo	1	
 710946	SitraForza	1	
 710947	SitraForza+	1	
 710948	SitraMondo	1	



710946



710947



710948









SITRAM ACCESSOIRES / ACCESSORIES

COUVERCLES ET CACHE-PLAQUES / LID AND HOTPLATE COVER

REF.     

CACHE-PLAQUE EN ACIER ÉMAILLÉ / ENAMELLED STEEL HOTPLATE COVER













 710075	16 / 6,30	•	10	
 710076	20 / 7,88	•	10	
 710077	16 / 6,30	•	10	
 710078	20 / 7,88	•	10	

COUVERCLE EN VERRE / GLASS LID



poignée escamotable
fold-down handle















 710281	16 / 6,30		10	
 710282	18 / 7,09		10	
 710283	20 / 7,88		10	
 710284	24 / 9,46		10	
 710358	28 / 11,03		10	

COUVERCLE INOX AVEC POIGNÉE THERMORÉSISTANTE / STAINLESS STEEL LID WITH HEAT-RESISTANT HANDLE



710240 à 710243

 710240	12-16 / 4,73-6,30	couvercle universel / universal lid	12	
 710241	16-20 / 6,30-7,88	couvercle universel / universal lid	12	
 710242	22-26 / 8,67-10,24	couvercle universel / universal lid	12	
 710243	28-32 / 11,03-12,61	couvercle universel / universal lid	12	
 710262	28-32 / 11,03-12,61	couvercle vapeur / steam lid	6	
 710247	16-20 / 6,30-7,88	couvercle passoire / strainer lid	12	



710262



710247

LAVE
VAISSELLE
DISHWASHER
Safe



NETTOYAGE
FACILE
EASY
TO CLEAN





Gers *Equipement*

Arts de la cuisine et Arts de la table

Centre Economique de Mirande

Av. de Larbonne - BP 7 - 32300 Mirande

Tél : 05.62.64.25.25 - Fax : 05.62.66.68.25

Usine Sitram :

36170 - St. Benoit Du Sault - France

www.sitram.fr

French Durable Professional